



*Communications Technology Training
Workbook*

**Connector
Attachment**

**HELIAX® Cable
Connectors and
Accessories**

**THIS WORKBOOK IS FOR REFERENCE USE ONLY:
ALWAYS READ INSTRUCTION BULLETINS**

Andrew Institute®

Leading the way in Telecommunications Installation Training

Installation Techniques To Ensure Quality!

Andrew products and people are at the forefront of connecting the wireless world. As the industry evolves, the Andrew Institute is committed to providing you with quality, effective training. Our trainers deliver knowledge that can develop your skills and self-assurance, as well as benefit your system performance and reliability.

Dedicated Andrew Institute trainers will share their proven installation techniques and expertise with you in one or two-day sessions.

"Build an Agenda" Customize Your Training:

Connector Attachment (*1 hour per connector*)

- Cable concepts
- Connector attachment
- Accessories

Fundamentals of VSWR (*4 hours*)

- Typical site configuration
- Plot/sweep interpretation
- Troubleshooting
- Hands on exercise with Anritsu Site Master™

Remote Controlled Variable Electrical Downtilt Antenna **(Teletilt® Systems)** (*2 hours*)

- What is Downtilt
- Difference Between Mechanical and Electrical Downtilt
- Antennas and System Configurations
- Actuator Installation
- Device Configuration and Operation

Terrestrial Microwave Systems (*2 days*)

- RF theory/TMW fundamentals
- Antenna installation
- Path alignment
- Pressurization fundamentals

Who should attend:

Anyone who works with a communications system can benefit: installers, project managers, field engineers

We appreciate this opportunity to assist you in better serving your customers. Thank you for your commitment to quality and customer service.

Customer Service Center

North America: + (1)-800-255-1479

International: + (1)-779-435-6500

Andrew Institute

United States and Canada: + (1)-779-435-6231

Central and South America: + (55)-15-210-241-51

China: + (86)-512-6252-0805

Europe: + (44)-(0)-1592-786-005

South Africa: + (27)-11-719-6000

Elsewhere: + (1)-779-435-6231

Bulletin TP-100433.2-EN, Copyright © 2008 CommScope, Inc. All rights reserved.

No part of this publication may be reproduced, stored in a retrieval system, or transmitted in any form without the prior written permission of CommScope, Inc.

Table of Contents

Attaching HELIAX[®] Connectors	1
Connector Type Numbering System	2
Connector 1 -- F4PDMV2-C Connector for FSJ4 (1/2") Flexible Foam-dielectric Cable .	4
Connector 2 -- L4PNM-H Connector for LDF4 (1/2") Foam-dielectric Cable	8
Connector 3 -- L4PDM-RC Connector for LDF4 (1/2") Foam-dielectric Cable	14
Connector 4 -- L5PDF-RC Connector for LDF5 (7/8") Foam-dielectric Cable	18
Connector 5 -- L5PDF-RPC Connector for LDF5 (7/8") Foam-dielectric Cable	22
V5PDF-RPC Connector for VXL5 (7/8") Foam-dielectric Cable	22
Connector 6 -- A5TDF-PS Connector for AVA5 (7/8") Foam-dielectric Cable	28
Connector 7 -- L6PDF-RPC Connector for LDF6 (1-1/4") Foam-dielectric Cable	32
L7PDF-RPC Connector for LDF7 (1-5/8") Foam-dielectric Cable	32
Connector 8 -- L7PDF-RC Connector for LDF7 (1-5/8") Foam-dielectric Cable	36
Connector 9 -- A7TDF-PS Connector for AVA7 (1-5/8") Foam-dielectric Cable	40
Connector 10 -- 152SE Connector for EW52 Elliptical Waveguide	44
Accessories	49
Accessory 1 -- Weatherproofing Kit, WeatherShield [™] for Main Line/Jumper for Connectors/Antennas	50
Accessory 2 -- SureGround [™] and Compact SureGround [™] Version 2 Grounding Kits for HELIAX LDF Coaxial Cable	60
Accessory 3 -- Grounding Kit for HELIAX Coaxial Cable and Elliptical Waveguide	70
Accessory 4 -- Hoisting Grip for HELIAX Coaxial Cable and Elliptical Waveguide	76
Accessory 5 -- Support/Hoisting Grip for HELIAX Coaxial Cable	80

Table of Contents

Appendixes83

Appendix 1 -- Glossary84

Appendix 2 -- Connector Replacement Parts97

Appendix 3 -- Inner Connector Soldering Techniques98

Appendix 4 -- Connector Attachment Checklist100

Appendix 5 -- Cable and Waveguide Bending Radii100

Appendix 6 -- Coupling Torque Data for all N and 7-16 DIN Type Connectors101

Appendix 7 -- Tool Reference Locations101

Appendix 8 -- Lightning Protection of Transmission Lines104

Appendix 9 -- Replaceable Gas Tube Surge Arrestors108

Appendix 10 -- Fire Retardant Cables and Waveguides108

Appendix 11 -- Radio Frequency (RF) Communications Basics110

Appendix 12 -- Conversion Tables111

Appendix 13 -- Cable Hanger Spacing112



Vertical text on the right edge of the page, possibly a page number or margin indicator.

Attaching HELIAX® Connectors

Connector Type Numbering System

Andrew uses a functional system of connector type numbering that installation, purchasing, and receiving personnel should find easy to understand. With a few exceptions, it is limited to Type N and DIN connectors. Here are three examples:

Type number L2NM: Cable key **L2** denotes it is used with **LDF2-50** cable
Connector key **NM** denotes it is an **N Male**

Type number L4PNF: Cable key **L4** denotes it is used with **LDF4-50** cable
Connector key **PNF** denotes it is a **Plated N Female**

Type number F4PDM-C: Cable key **F4** denotes it is used with **FSJ4-50B** cable
Connector key **PDM** denotes it is a **Plated 7-16 DIN Male**
Suffix key **C** denotes it features a **captivated pin**

Cable Keys

E2	EFX2-50	3/8"
F1	FSJ1-50A	1/4"
F2	FSJ2-50	3/8"
F4	FSJ4-50B	1/2"
H4	HJ4-50	1/2"
H4.5	HJ4.5-50	5/8"
H5	HJ5-50	7/8"
H7	HJ7-50A	1-5/8"
H8	HJ8-50B	3"
H11	HJ11-50	4"
H9	HJ9-50	5"
H9HP	HJ9HP-50	5" (high power)
H12	HJ12-50	2-1/4"
L1	LDF1-50	1/4"
L2	LDF2-50	3/8"
L4	LDF4-50A	1/2"
L4.5	LDF4.5-50	5/8"
L5	LDF5-50A	7/8"
A5	AVA5-50	7/8"
V5	VXL5-50	7/8"
L6	LDF6-50A	1-1/4"
V6	VXL6-50	1-1/4"
L7	LDF7-50A	1-5/8"
V7	VXL7-50	1-5/8"
A7	AVA7-50	1-5/8"
L12	LDF12-50	2-1/4"

Connector Keys

NM	N male
NF	N female
NR	N male, right angle
PNM	Plated N male
PNR	Plated N male, right angle
PNF	Plated N female
PBM	Plated BNC male
PSM	Plated SMA male
PSF	Plated SMA female
PSR	Plated SMA male, right angle
PDM	Plated 7-16 DIN male
PDF	Plated 7-16 DIN female
PDR	Plated 7-16 DIN male, right angle
PKM	Plated 4.1-9.5 DIN male
PKR	Plated 4.1-9.5 DIN male, right angle
PTM	Plated TNC male
PTF	Plated TNC female
SM	SMA male
SF	SMA female
UM	UHF male
UF	UHF female
MU	Mini UHF male
FM	CATV F male
M	EIA flange male
F	EIA flange female
V2	Version 2
TDF	Tri-metal 7-16 DIN female
TDM	Tri-metal 7-16 DIN male

Suffix Keys

HF	High frequency
BH	Bulkhead
7550	75-ohm cable, 50-ohm mating pin
7570	75-ohm cable, 70-ohm mating pin
C	Captivated inner pin attachment (solderless)
PM	Panel mount
I	Indoor use
IC	Indoor use, captivated pin
PMC	Panel mount, captivated pin
H	Hex coupling nut
BHC	Bulkhead, captivated pin
T	Tunable
HC	Hex coupling nut, captivated pin inner contact attachment
PR	Pressure port
IP	Installer pax
RP	Reel pax
RC	RingFlare™, captivated pin inner contact attachment
RPC	OnePiece™ RingFlare plus, captivated pin inner
B	Gas barrier
P	Gas pass
PS	Possitive Stop™

Attaching HELIAX® Connectors

Notes:

Lined area for taking notes, consisting of multiple horizontal lines.

Vertical text on the left margin, possibly bleed-through from another page.

Connector 1

F4PDMV2-C Connector for FSJ4 (1/2") Flexible Foam-dielectric Cable

Installation Tips

- Always straighten a minimum of 6" (150 mm) of the cable end.
- Use EASIX® tools where applicable.
- Use an accurate scale for all measurements.
- Use a knife to remove the cable jacket, but do not score the outer conductor.
- Apply silicone grease with a brush, not with your fingers.
- Use a cutoff guide to trim the inner conductor to the proper length.
- Deburr the inner and outer conductors using a file or knife.
- When tightening the connection with wrenches, hold the clamping nut stationary and turn the outer body according to the torque specified.

1

Straighten the last 6" (150 mm) of cable and place the cable in the large groove of the EASIX® cutting tool (Andrew MCPT-1412). Butt the cable end against the stop of the tool. Press the tool blade lightly into the cable and rotate it clockwise, as viewed from the cable end, until it cuts through the outer conductor. *If not, apply more pressure or replace the blade and try again.*



2

Remove the cut piece of the cable by unscrewing it in a counterclockwise direction, as viewed from the cable end.



3

Remove 27/32" (21 mm) of cable jacket by first cutting around the outer conductor.

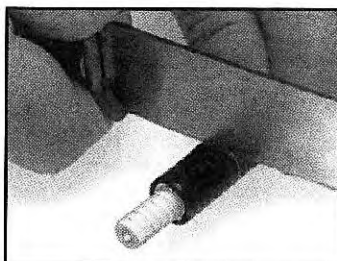
**4**

Slice through the jacket along the outer conductor and peel off the jacket.

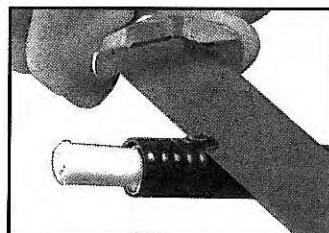
**5**

Cut through the foam around the inner conductor with a knife (Andrew 224352). Then, cut away four large sections of foam by slicing along the inner conductor.

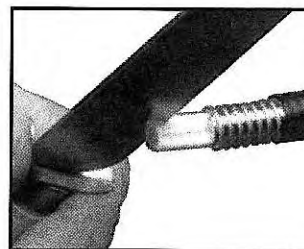
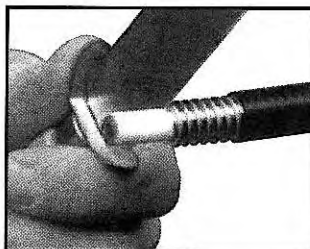
**6**

Remove the foam adhesive by pushing the foam towards the cable end with the knife edge held at 90° to the inner conductor.

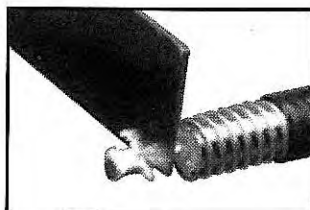
**7**

Slide the cut-off guide (Andrew 244494) onto the inner conductor and cut the conductor flush with the guide to a length of 9/32" (7 mm), using wire snips (Andrew 224353). Remove any protruding conductor with a file.

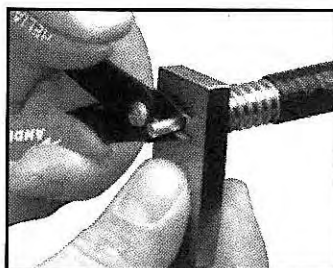

Notes:

8

Remove any burrs with a point file (Andrew 224356), slightly tapering the end of the inner conductor, or use a chamfer tool (Andrew 241953) by rotating it clockwise to remove any burrs.

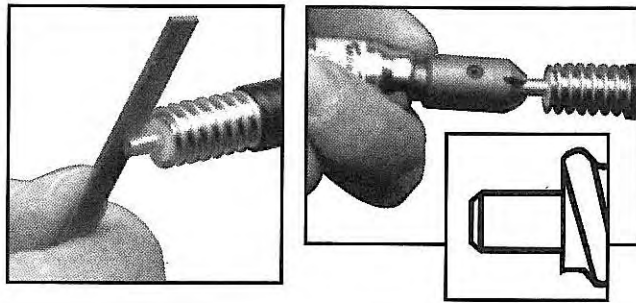

Note:

Steps 1 through 8 may also be accomplished in one operation by using the EASIAx PLUS® Cable Prep Tool (Andrew CPT-F4) as shown here.

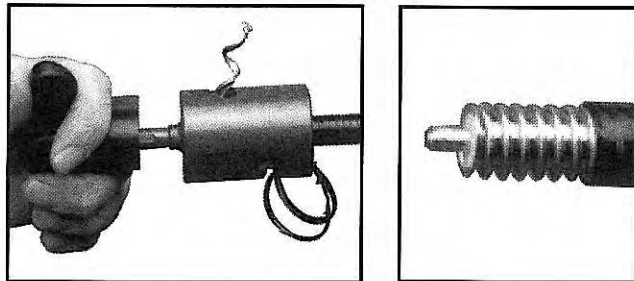

9

Remove copper particles from the foam with a nylon or wire brush.

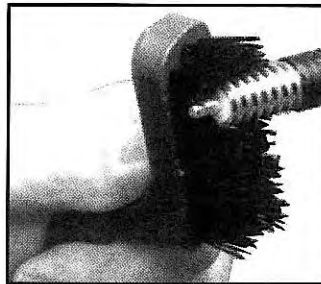

10

Stretch the threaded gasket over the outer conductor to form a gap of 1/16" (1.5 mm) from the jacket. Make sure that the gasket threads are fully engaged. Apply a thin layer of silicone grease to the outer surface of the gasket.

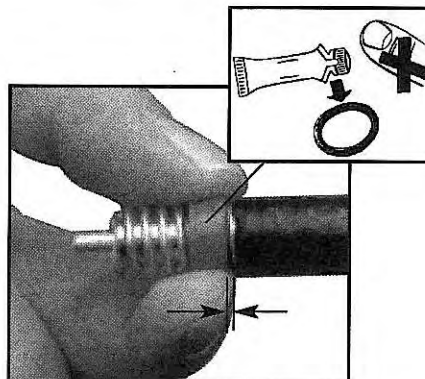

Notes:

11

Screw the clamping nut onto the outer conductor until it stops. *Make sure that the gasket does not protrude from the clamping nut, which forms a poor weather seal. If so, reinstall these parts.*

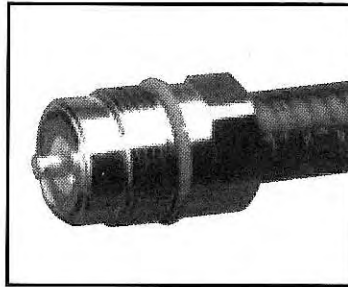
**12**

Slide the shrink tube onto the cable. Apply a thin coating of silicone grease to the O-ring.

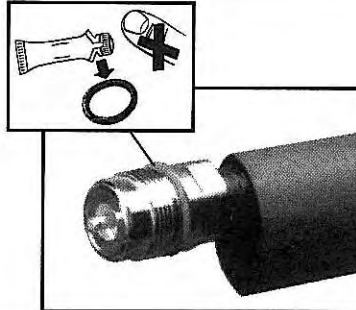
**13**

Tighten the connection with a torque wrench to a value from 20 to 22 lbf•ft (27 to 30 N•m). Make sure you hold the clamping nut stationary and rotate only the outer body. *Unscrew the connector body from the clamping nut to examine the flare. Reassemble the connector and tighten to the specified torque values.*

**14**

Position half the shrink tubing over the connector. Apply heat uniformly to the tubing, starting at the connector end. **DO NOT OVERHEAT OR CABLE DAMAGE MAY RESULT.** *The tubing is provided for cable strain relief and not as a moisture seal.*

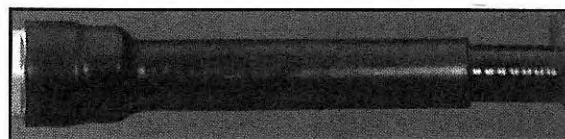
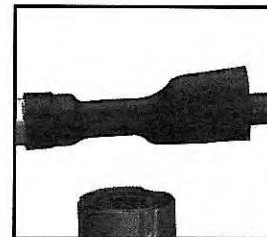
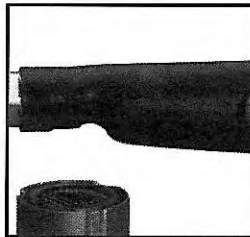
**Notes:**

Connector 2

L4PNM-H Connector for LDF4 (1/2") Foam-dielectric Cable

Installation Tips

- Always straighten a minimum of 6" (150 mm) of the cable end.
- Use EASIAx® tools where applicable.
- Use an accurate scale for all measurements.
- Use a knife to remove the cable jacket, but do not score the outer conductor.
- Apply silicone grease with a brush, not with your fingers.
- Use a flare tool to flare the outer conductor.
- Use a cutoff guide to trim the inner conductor to the proper length.
- Deburr the inner and outer conductors using a file or knife.
- Solder the inner connector pin, while holding it with pin pliers, according to the solder specifications and check the connector for straightness.
- Carefully inspect all solder joints and watch for melted foam.
- Remove excess solder using a knife or wire cutter. Use a leather buffing strap to remove excess solder flux. **DO NOT USE SANDPAPER.**
- When tightening the connection with wrenches, hold the clamping nut stationary and turn the outer body according to the torque specified.
- For N-male connectors, use the pin alignment tool to check the inner connector for straightness and adjust it as necessary.
- For N-male, N-female, DIN-male, and DIN-female connectors, verify pin depth using depth gauges, and adjust the inner connector as necessary.

Notes:

1

Straighten the last 6" (150 mm) of cable and remove 2" (51 mm) of cable jacket.

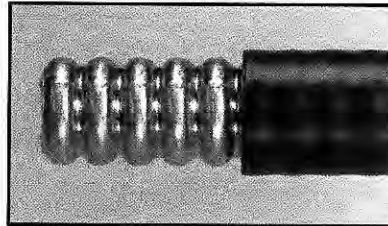

2

Place the cable in the groove of the EASIAx® cutting tool (Andrew MCPT-L4) with the corrugation guide in the valley nearest the jacket. Press the tool blades lightly into the cable and rotate the tool counterclockwise, as viewed from the cable end, until you cut through the outer conductor. *If not, apply more pressure or replace the blade that cuts the outer conductor and try again.*

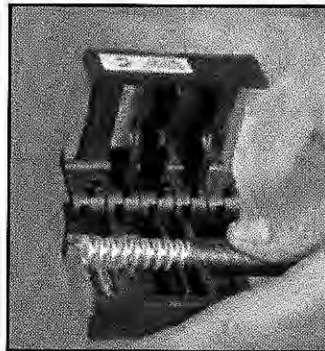

3

Remove the cut piece of the cable by pulling it off with pliers. Then, slice the cut section of jacket and remove it.

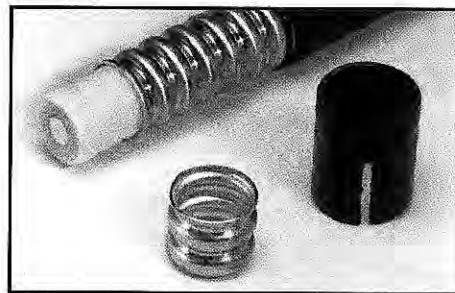

4

Place the small O-ring in the second valley of the outer conductor from the edge of the jacket. Apply silicone grease to the O-ring and slide the clamping nut fully onto the cable.

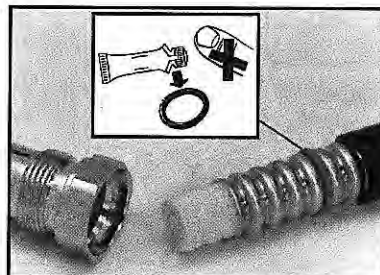

Notes:

5

Cut through the foam around the inner conductor with a knife (Andrew 224352). Then, cut away four large sections of foam by slicing along the inner conductor.

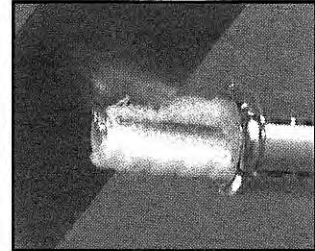
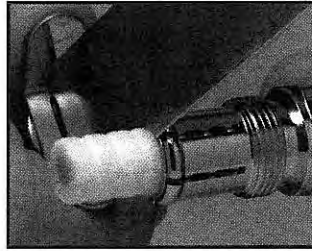

6

Remove the foam adhesive by pushing the foam towards the cable end with the knife edge held at 90° to the inner conductor.

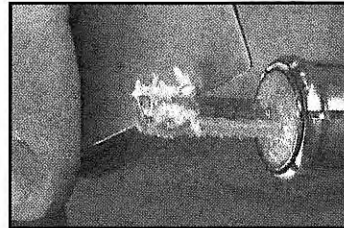

7

Slide the cut-off guide (Andrew 224361) onto the inner conductor and cut the conductor flush with the guide, a length of 7/32" (5 mm), using wire snips (Andrew 224353). Remove any protruding conductor with a file.

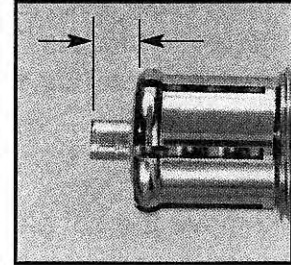
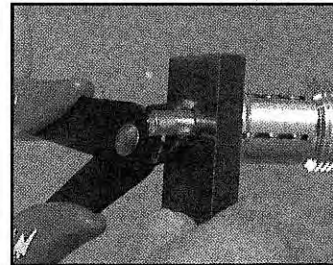

8

Remove any burrs with a point file (Andrew 224356). Slightly taper the end of the inner conductor using a chamfer tool (Andrew 241953) and rotating it clockwise. Remove any burrs.

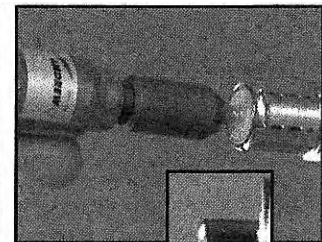
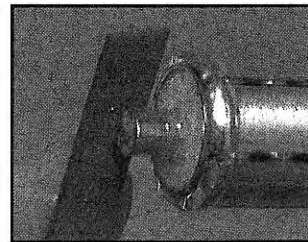

Notes:

9

Remove copper particles from the foam with a nylon or wire brush. *Such particles cause unwanted reflection of RF signal.*

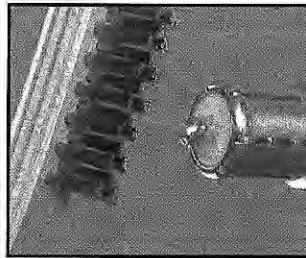
**10**

Start separation of the foam from outer conductor to provide for entry of the flare tool. Use a knife tip and press the foam towards the inner conductor.

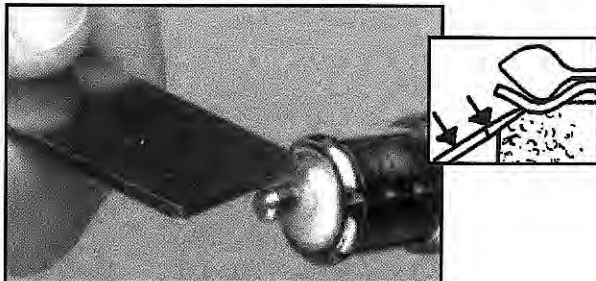
**11**

Slide the flare tool (Andrew 224363) onto the cable and rotate it to flare the outer conductor. Pull away any foam clinging to the outer conductor and press it toward the inner conductor.

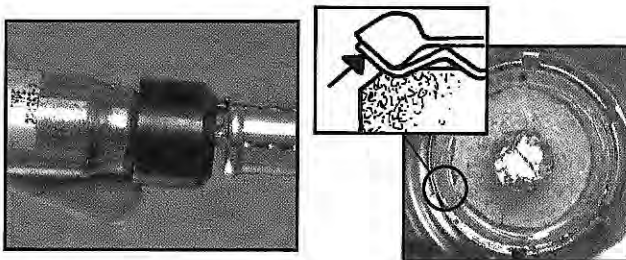
**12**

Hold the inner connector pin with pin pliers (Andrew 224377). Insert a small piece of solder to fill the connector cup.

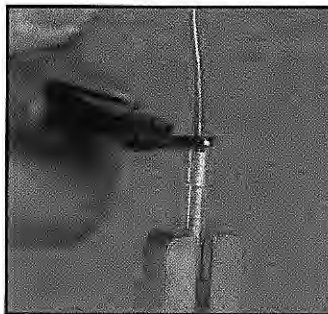
**13**

Barely melt the solder with a soldering iron so that the flux is retained; *overheating will burn away the flux, as evidenced by heavy smoke.*

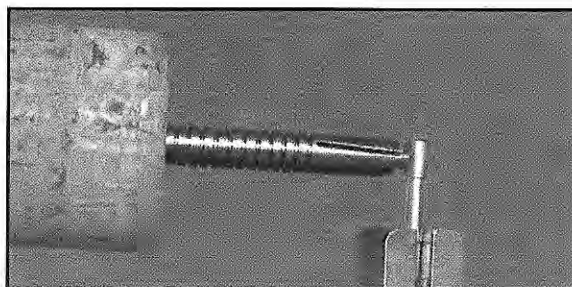

14

Place the inner connector pin onto the inner conductor with the pin cup holes at the sides. Apply heat under the connector and rotate it slightly to ensure good solder flow at the end of the cup. Remove any excess solder with wire snips (Andrew 224353).

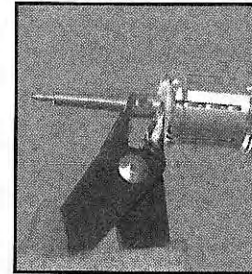
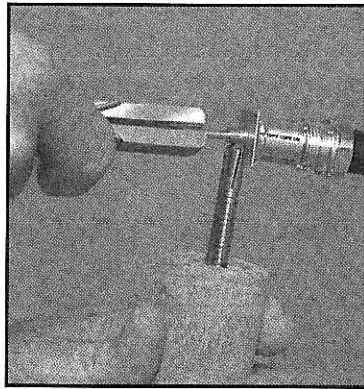

15

Place the O-ring into the groove of the clamping nut and apply a thin coating of silicone grease to the O-ring. Then, screw the connector body onto the clamping nut while holding the clamping nut stationary.

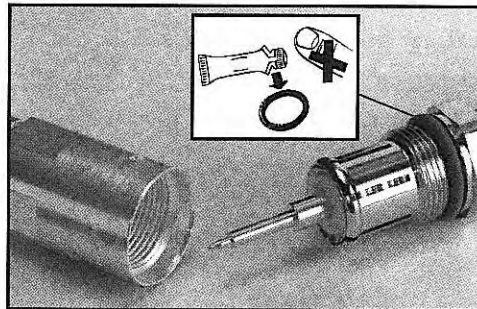

16

Tighten the connection with wrenches to the torque value of from 96 to 144 lbf·in (11 to 16 N·m). Make sure you hold the clamping nut stationary and rotate only the outer body.

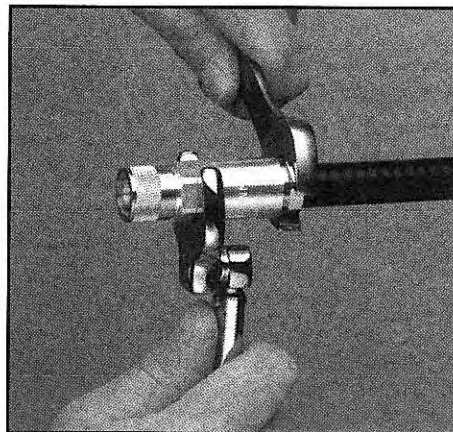

Notes:

17

Check the inner connector pin to be sure it is straight within the connector body by inserting the large end of the pin alignment tool (Andrew 224360). The tool end should stop at a depth of about 1/2" (13 mm). If not, use the small end of the tool to align the pin slightly.



18

Insert the plunger of the pin depth gauge (Andrew 224380) for the N-male connector fully into the connector. The other end of the plunger should be positioned between the two end surfaces of the gauge body, indicating that the inner connector pin depth is correct. If not, take the connector apart and adjust the pin position as indicated.

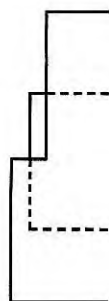
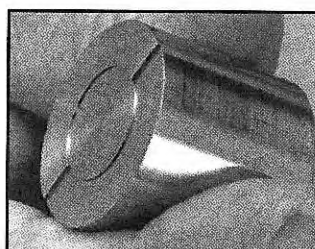

Correct pin depth - plunger is within surface limits

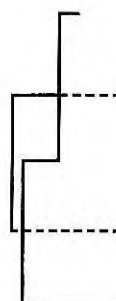

Pin out too far - shorten inner conductor

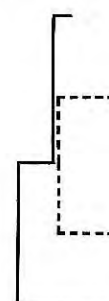

Pin in too far - position pin closer to connector end

Notes:

Connector 3 L4PDM-RC Connector for LDF4 (1/2") Foam-dielectric Cable

Installation Tips

- Always straighten a minimum of 6" (150 mm) of the cable end.
- Use EASIAX® tools where applicable.
- Use an accurate scale for all measurements.
- Use a knife to remove the cable jacket, but do not score the outer conductor.
- Apply silicone grease with a brush, not with your fingers.
- Deburr the inner and outer conductors using a file or knife.
- When tightening the connection with wrenches, hold the interface assembly stationary and turn the clamping body according to the torque specified.

1

Straighten the last 6" (150 mm) of cable and remove 2" (51 mm) of cable jacket.

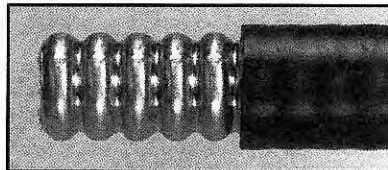

2

Place the cable in the groove of the EASIAX® cutting tool (Andrew MCPT-L4) with the corrugation guide in the valley nearest the jacket. Press the tool blades lightly into the cable and rotate the tool counterclockwise, as viewed from the cable end, until you cut through the outer conductor. *If not, apply more pressure or replace the blade that cuts the outer conductor and try again.*

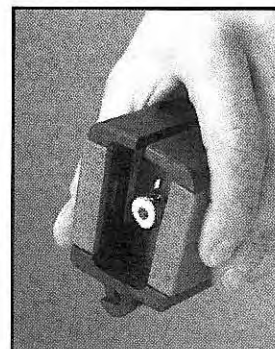
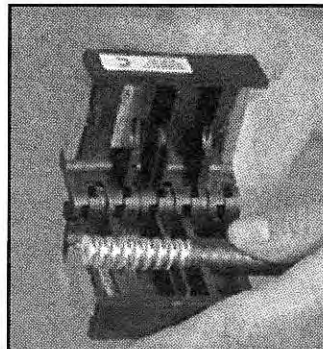

3

Remove the cut piece of the cable by pulling it off with pliers. Then, slice the cut section of jacket and remove it.

**Note:**

The cable can be fully prepared by using the EASIAx PLUS® Cable Prep Tool (Andrew CPT-L4ARC1) as shown here.

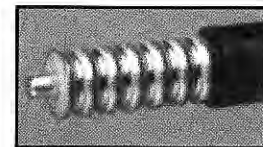
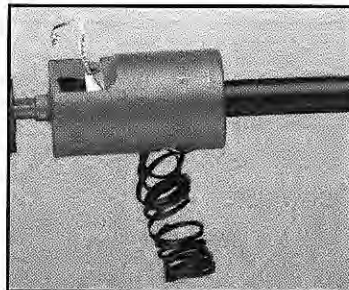
**4**

Place the small O-ring in the **first** valley of the outer conductor from the edge of the jacket and apply silicone grease to the O-ring. Push the unthreaded end of the clamping body onto the cable to expose two corrugation valleys. Place the spring ring into the first valley with care to avoid damaging the ring.

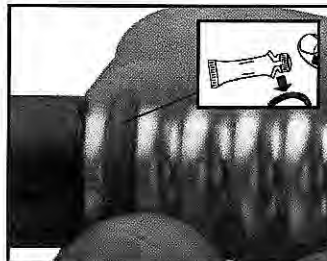
**5**

Cut through the foam around the inner conductor with a knife (Andrew 224352). Then, cut away four large sections of foam by slicing along the inner conductor.

**6**

Remove the foam adhesive by pushing the foam towards the cable end with the knife edge held at 90° to the inner conductor.



7

Cut the inner conductor to a length of 1/4" (6.5 mm), using the plastic saw guide provided and wire snips (Andrew 224353). Remove any protruding conductor with a file.

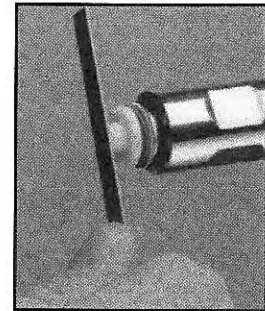
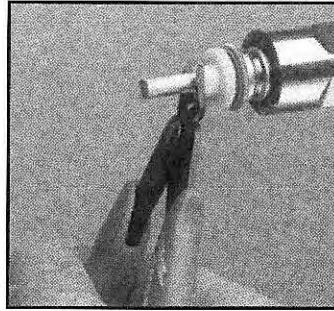

8

Remove any burrs with a file (Andrew 224356). Slightly taper the end of the inner conductor using a chamfer tool (Andrew 241953) and rotating it clockwise. Remove any burrs.

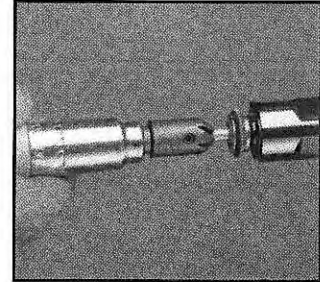
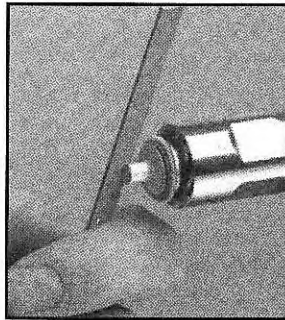

9

Remove copper particles from the foam with a nylon brush. *Such particles cause unwanted reflection of signal.*

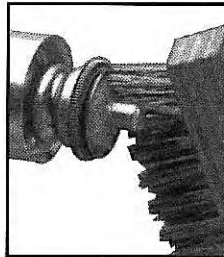

10

Start separation of the foam from the outer conductor with a knife tip by pressing the foam toward the inner conductor all the way around. This provides for entry of the flaring edge within the interface body.

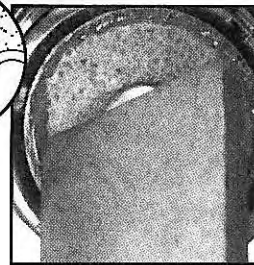

Notes:

11

Place the O-ring into the groove of the interface assembly and apply a thin coating of silicone grease to the O-ring. Carefully place the interface assembly over the inner conductor. Screw the clamping body onto the interface assembly to flare the outer conductor. Tighten the connection with a torque wrench (Andrew 245154) to a value of from 14 to 18 lbf•ft (19 to 25 N•m). *Make sure you hold the connector interface stationary and rotate only the clamping body.*

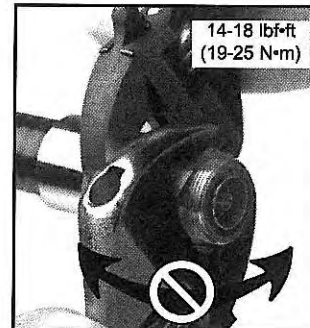
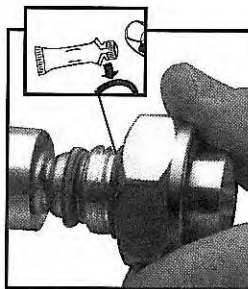

12

Disassemble the connection and inspect the flared outer conductor. It should be uniform and free of debris such as bits of foam and copper particles. Remove debris with a wire or nylon brush.

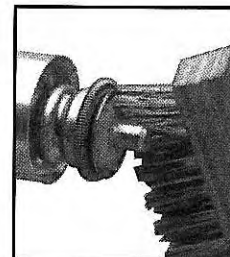
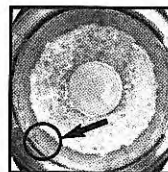
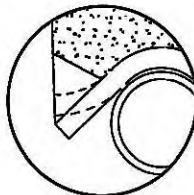

13

Reassemble the connector and tighten the connection with a torque wrench (Andrew 245154) to a value of 14 to 18 lbf•ft (19 to 25 N•m). *Make sure you hold the connector interface stationary and rotate only the clamping body.*

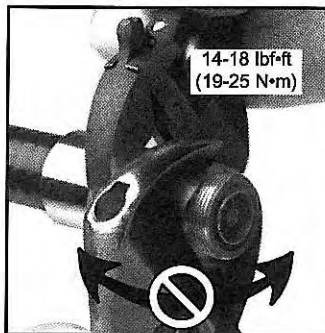

Notes:

Connector 4 L5PDF-RC Connector for LDF5-50A (7/8") Foam-dielectric Cable

Installation Tips

- Always straighten a minimum of 6" (150 mm) of the cable end.
- Use EASIAX® tools where applicable.
- Use an accurate scale for all measurements.
- Use a knife to remove the cable jacket, but do not score the outer conductor.
- Deburr the inner and outer conductors using a knife.
- When tightening the connection with wrenches, hold the clamping nut stationary and turn the outer body according to the torque specified.

1

Straighten the last 6" (150 mm) of cable. Remove 3" (76 mm) of cable jacket by first cutting around the outer conductor.

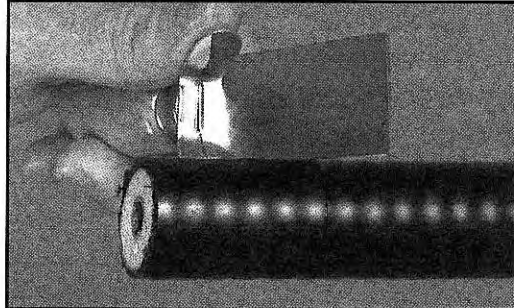

2

Slice through the jacket along the outer conductor and peel off the jacket.

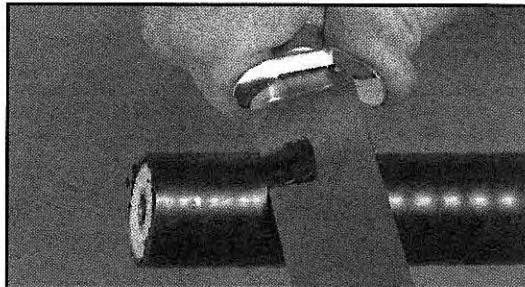

Notes:

3

Place the cable in the groove of the cutting tool (Andrew MCPT-78) with the corrugation guide in the groove nearest the jacket. *Make sure that the jacket blade is in the correct position for RC preparation dimensions.* Gently close the tool, apply light pressure, and rotate it counterclockwise, as viewed from the cable end. Continue rotating the tool until the front blade cuts completely through the outer and inner conductors. Rotate two more revolutions while applying light pressure to make sure that the back blade scores the cable jacket. *If not, replace the blades.*

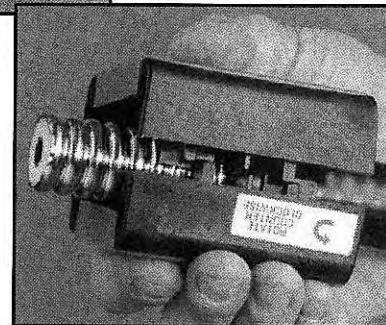
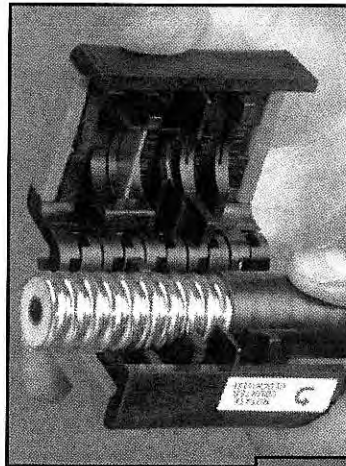
**4**

Slice through the jacket from the blade cut to the end of the cable and peel away the jacket.

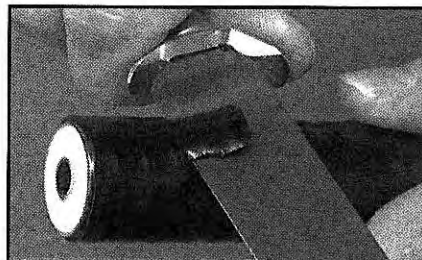
**Note:**

Steps 1 through 4 may also be accomplished in one operation by using the EASIAx PLUS® Cable Prep Tool (Andrew CPT-78U). *Make sure that the jacket blade is in the correct position for RC preparation dimensions.*

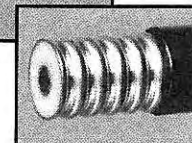
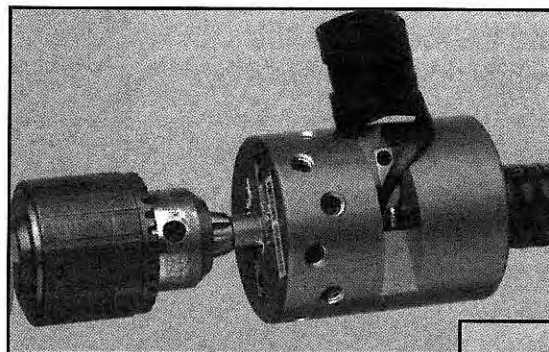

5

Place the thick O-ring in the first corrugation valley of the outer conductor from the edge of the jacket. Apply silicone grease to the O-ring. Position the clamping body so that the threaded end faces away from the jacket and push the body onto the cable to expose one corrugation valley.

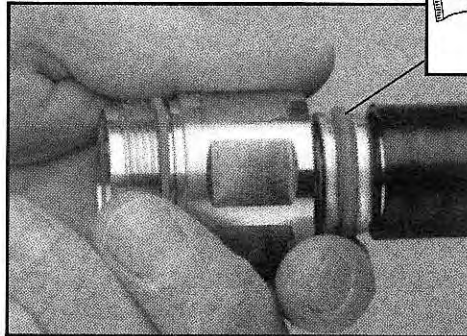

6

Place the spring ring into the first exposed corrugation valley. Use care to avoid damaging the ring.

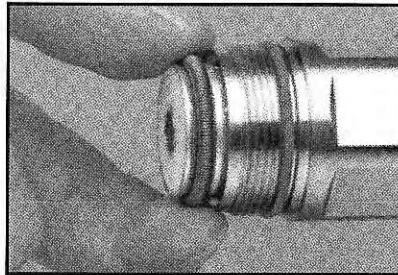

7

Remove the sharp edge from the inner conductor with the tip of a knife.

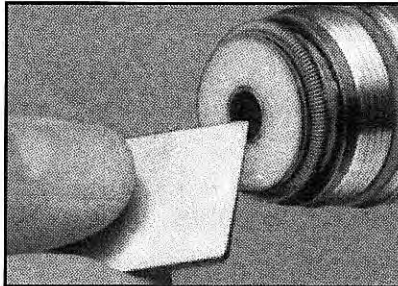

8

Separate the foam from the outer conductor with a knife by pressing the foam toward the inner conductor. This provides for entry of the flaring edge within the interface body.

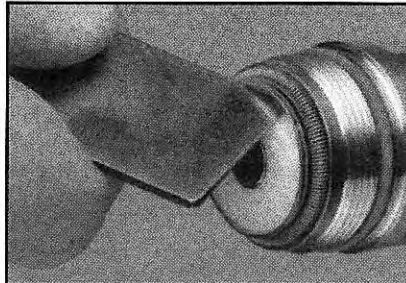

Notes:

9

Pull the clamping body over the spring ring to captivate it. Slide the flare tool (Andrew 224368) into the cable so that the flare tip enters the area where the foam has been pressed. Rotate the tool to flare the outer conductor. Pull away any foam clinging to the outer conductor and press it toward the inner conductor.

Note: Excess flaring of the outer conductor will interfere with the interface assembly sliding into place.

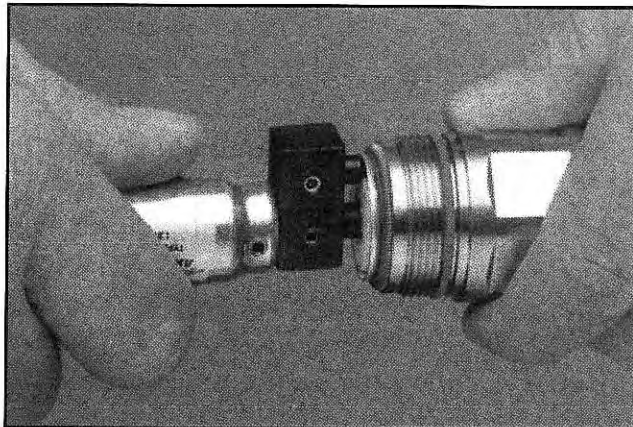
**10**

Add the interface assembly by carefully guiding the spring fingers of the inner contact into the inner conductor of the cable. Push the interface assembly into place.

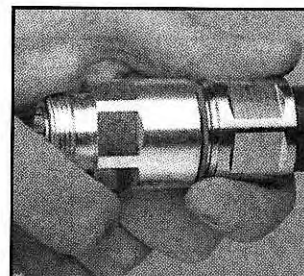
**11**

Thread the clamping body onto the interface assembly. Tighten the connection with a torque wrench (Andrew 244378) to the value of from 15 to 19 lbf•ft (20.3 to 25.7 N•m). Make sure you hold the interface assembly stationary with a wrench (Andrew 244459-5) and rotate only the clamping body.

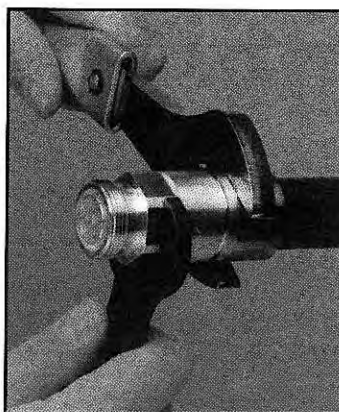
**Notes:**

Connector 5

L5PDF-RPC Connector for LDF5-50A (7/8") Foam-dielectric Cable
V5PDF-RPC Connector for VXL5-50 (7/8") Foam-dielectric Cable

Installation Tips

- Always straighten a minimum of 6" (150 mm) of the cable end.
- Use EASIAX® tools where applicable.
- Use an accurate scale for all measurements.
- Use a knife to remove the cable jacket, but do not score the outer conductor.
- Deburr the inner and outer conductors using a file or knife.
- When tightening the connection with wrenches, hold the outer body stationary and turn the clamping nut according to the torque specified.

1

Straighten the last 6" (150 mm) of cable. Remove 3" (76 mm) of cable jacket by first cutting around the outer conductor.

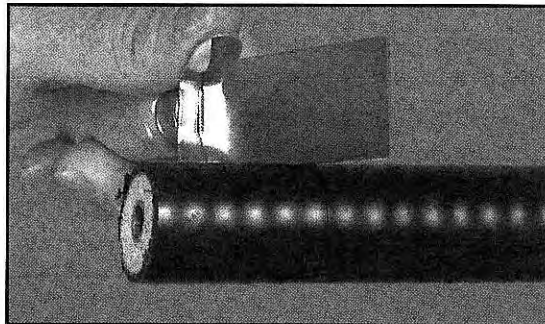

2

Slice through the jacket along the outer conductor and peel off the jacket.

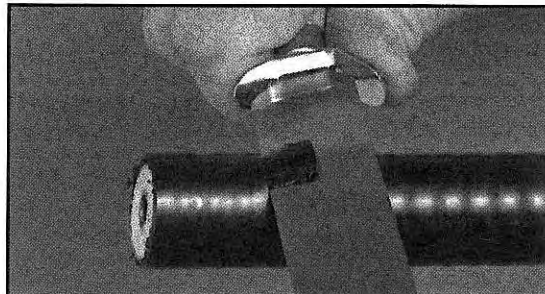

Notes:

L5PDF-RPC
V5PDF-RPC**3**

Place the cable in the groove of the cutting tool (Andrew MCPT-78) with the corrugation guide in the groove nearest the jacket. *Make sure that the jacket blade is in the correct position for RPC preparation dimensions.* Gently close the tool, apply light pressure, and rotate it counterclockwise, as viewed from the cable end. Continue rotating the tool until the front blade cuts completely through the outer and inner conductors. Rotate two more revolutions while applying light pressure to make sure that the back blade scores the cable jacket. *If not, replace the blades.*

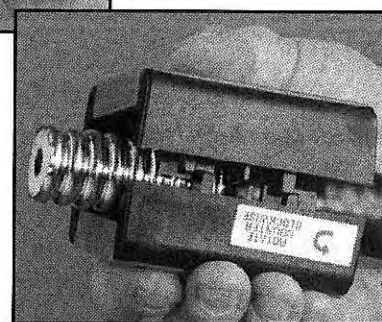
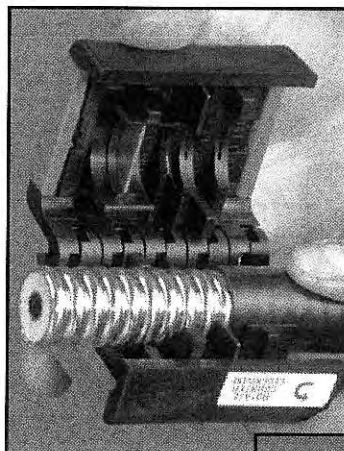
**4**

Slice through the jacket from the score mark to the end of the cable and peel off the jacket.

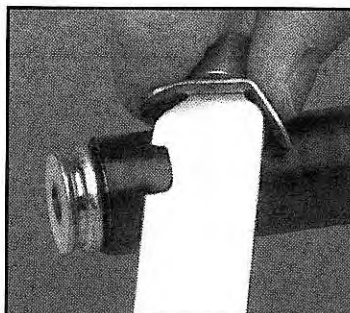
**Note:(L5PDF-RPC Only)**

Steps 1 through 4 may also be accomplished in one operation using the EASIAx PLUS® Cable Prep Tool (Andrew CPT-78U). *Make sure that the jacket blade is in the correct position for RPC preparation dimensions.*

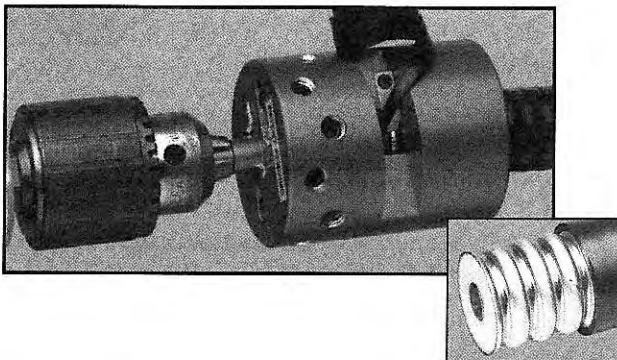
**Notes:**

5

Remove the sharp edge from the inner conductor with the tip of a knife.

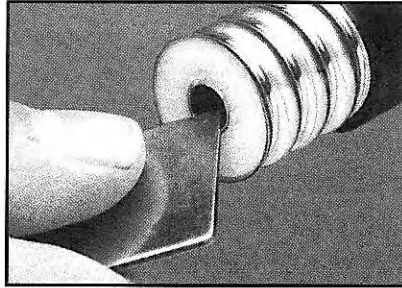

6

Separate the foam from the outer conductor with a knife by pressing the foam toward the inner conductor. This provides for entry of the flaring edge within the interface body. *Inspect the outer conductor to ensure it is in its original round and undistorted shape.*

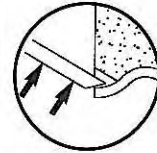
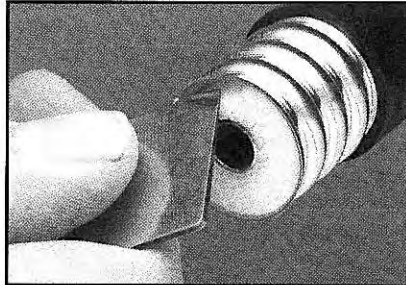

Note:

Step 6 may also be accomplished in one operation using the Foam Separation Tool provided with the connector. This provides for entry of the flaring edge within the interface body. *Inspect the outer conductor to ensure it is in its original round and undistorted shape.*

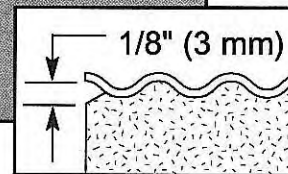
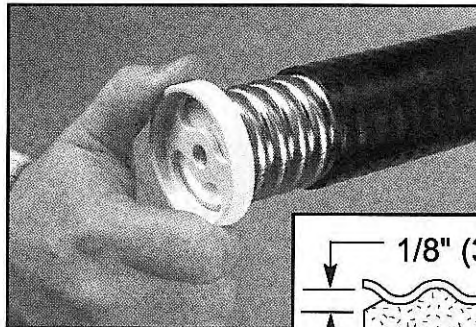

Notes:

7 (V5PDF-RPC Only)

Screw the inner connector stub into the inner conductor with the rod provided. The shoulder of the stub should butt against the inner conductor. *Keep the midpoint of the rod within the stub to avoid bending the rod.*

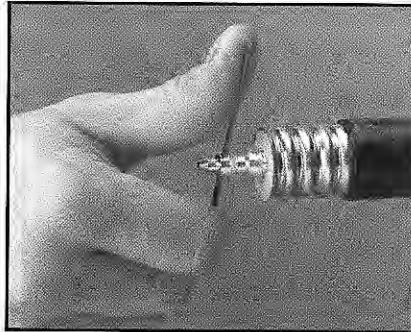

8

Screw the clamping body into the connector body one half turn to ensure that the threads are engaged.

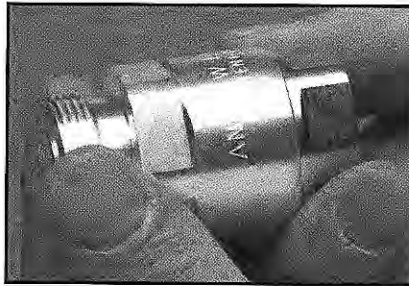

9

Push the connector assembly all the way onto the cable. *All gaskets are preinstalled and do not require lubrication.*

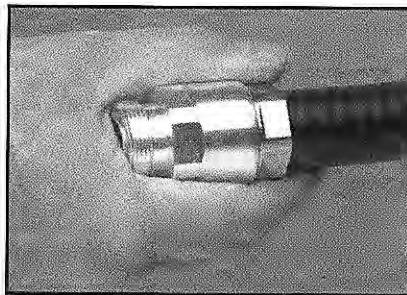

Notes:

10

Screw the clamping body fully into the connector while pushing on the connector end. Then try to pull the connector assembly off the cable. If the connection remains secure, the attachment was done correctly.

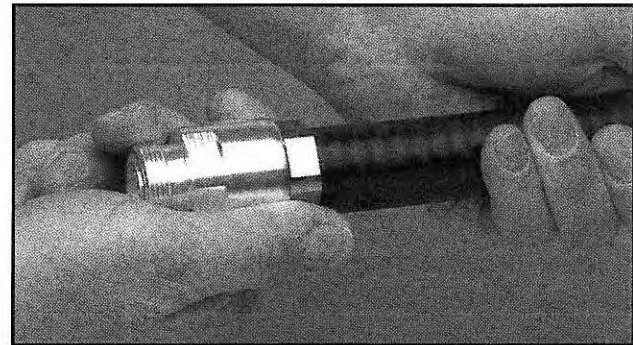
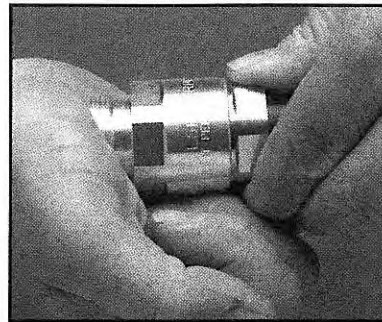

11

Tighten the connection with a torque wrench (Andrew 244378) to a value from 22 to 24 lbf·ft (27 to 32.5 N·m). *Make sure you hold the connector body stationary with a wrench and rotate only the clamping body.*



Notes:

Connector 6 A5TDF-PS Connector for AVA5-50 (7/8") Foam-dielectric Cable

Installation Tips

- Always straighten a minimum of 6" (150 mm) of the cable end.
- Use EASIAX® tools where applicable.
- Use an accurate scale for all measurements.
- Use a knife to remove the cable jacket, but do not score the outer conductor.
- Deburr the inner and outer conductors using a knife.
- When tightening the connection with wrenches, hold the clamping nut stationary and turn the outer body according to the torque specified.

1

Straighten the last 6" (150 mm) of cable. Remove 3" (76 mm) of cable jacket by first cutting around the outer conductor.

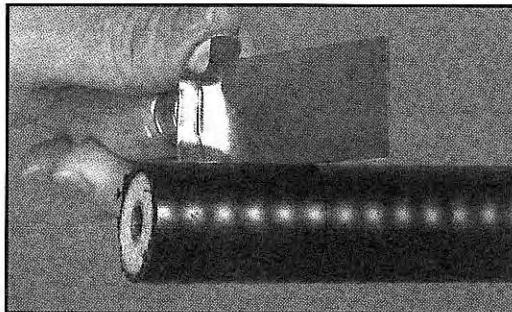

2

Slice through the jacket along the outer conductor and peel off the jacket.

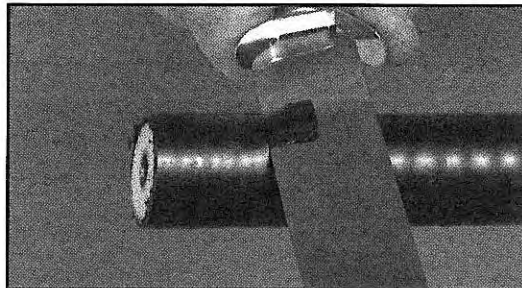

Notes:

3

Place the cable in the groove of the cutting tool (Andrew A5MCPT-78) with the corrugation guide in the groove nearest the jacket. *Make sure that the jacket blade is in the correct position for RC preparation dimensions.* Gently close the tool, apply light pressure, and rotate it clockwise, as viewed from the cable end. Continue rotating the tool until the front blade cuts completely through the outer and inner conductors. Rotate two more revolutions while applying light pressure to make sure that the back blade scores the cable jacket. *If not, replace the blades.*

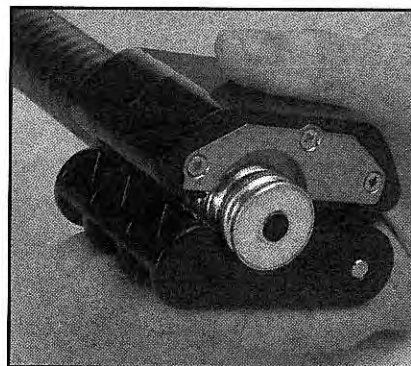
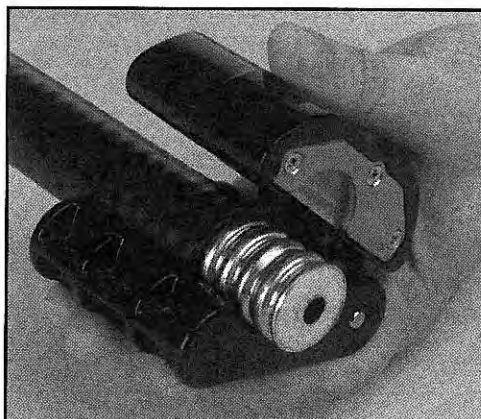
**4**

Slice through the jacket from the blade cut to the end of the cable and peel away the jacket.

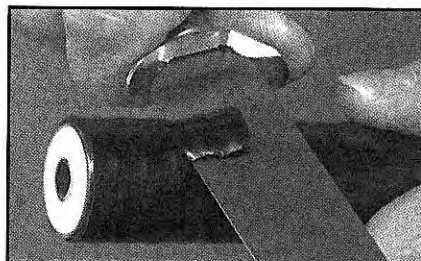
**Note:**

Steps 1 through 4 may also be accomplished in one operation by using the EASIAx PLUS® Cable Prep Tool (Andrew CPT-78U). *Make sure that the jacket blade is in the correct position for RC preparation dimensions.*

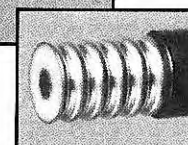
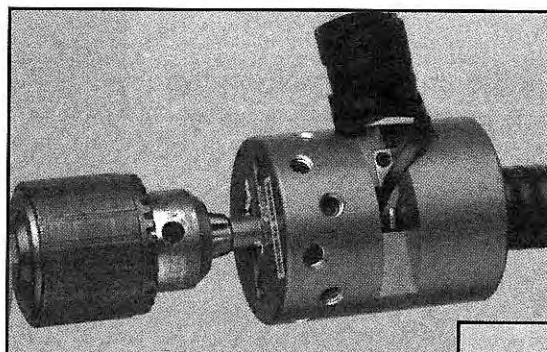

5

Separate the foam from the outer conductor in one operation using the Foam Separation Tool provided with the connector. This provides for entry of the flaring edge within the interface body. *Inspect the outer conductor to ensure it is in its original round and undistorted shape.*

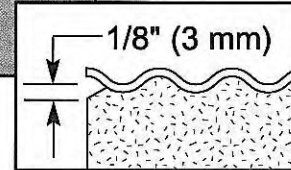
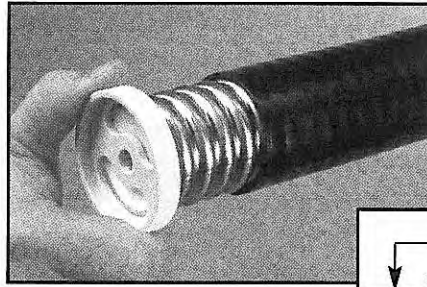

6

Position the clamping body so that the threaded end faces away from the jacket and push the body onto the cable to expose one corrugation valley.

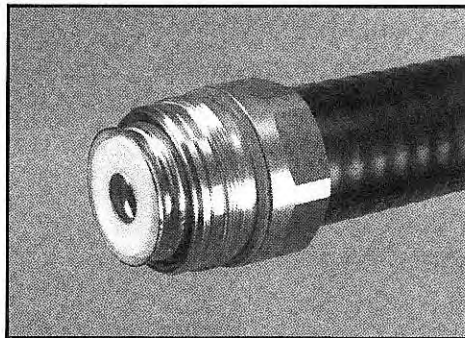

7

Place the spring ring into the first exposed corrugation valley. Use care to avoid damaging the ring.

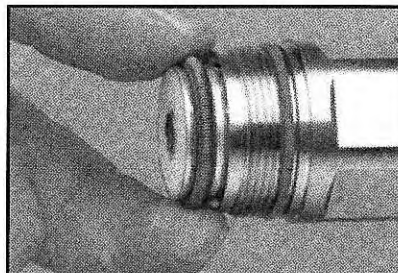

8

Remove the sharp edge from the inner conductor with the tip of a knife.

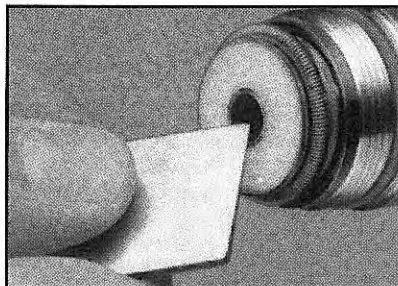

Notes:

9

Pull the clamping body over the spring ring to captivate it. Slide the flare tool (Andrew 224368) into the cable so that the flare tip enters the area where the foam has been pressed. Rotate the tool to flare the outer conductor. Pull away any foam clinging to the outer conductor and press it toward the inner conductor.

Note: Excess flaring of the outer conductor will interfere with the interface assembly sliding into place.

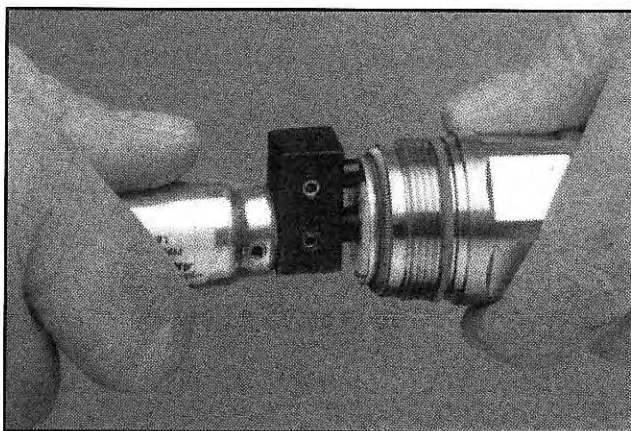
**10**

Add the interface assembly by carefully guiding the spring fingers of the inner contact into the inner conductor of the cable. Push the interface assembly into place.

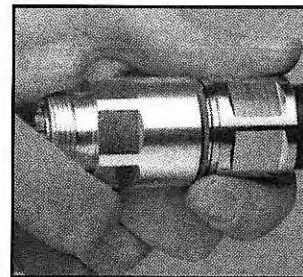
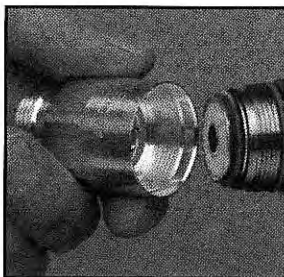
**11**

Carefully guide the spring fingers of the inner contact into the inner conductor of the cable. It will take less than 3/4 rotation to fully tighten the connection. *Make sure you hold the interface assembly with a wrench stationary and rotate only the clamping body. No gap should be present between clamping body and interface assembly.*

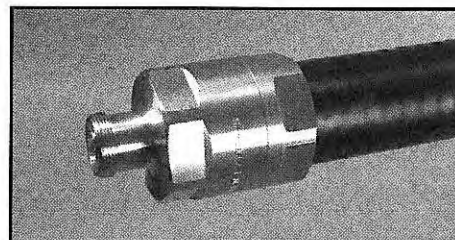
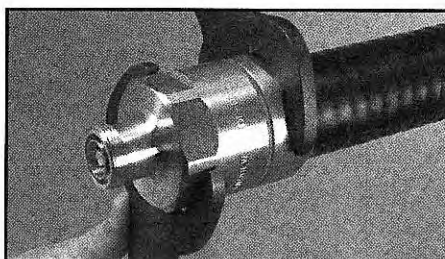
**Notes:**

Connector 7

L6PDF-RPC Connector for LDF6 (1-1/4") Foam-dielectric Cable
L7PDF-RPC Connector for LDF7 (1-5/8") Foam-dielectric Cable

Installation Tips

- Always straighten a minimum of 12" (300 mm) of the cable end.
- Use an accurate scale for all measurements.
- Use a knife to remove the cable jacket, but do not score the outer conductor.
- Deburr the inner and outer conductors using a file or knife.
- When tightening the connection with wrenches, hold the interface assembly stationary and rotate the clamping body according to the torque specified.

1

Straighten the last 12" (300 mm) of cable.

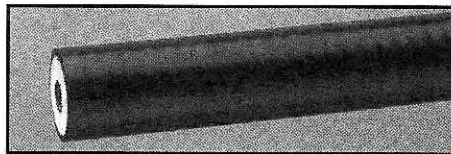

Note:

The cable can be fully prepared by using an EASIAX PLUS® Cable Prep Tool (Andrew CPTL6 for 1-1/4" or CPT-158U for 1-5/8") as shown here.

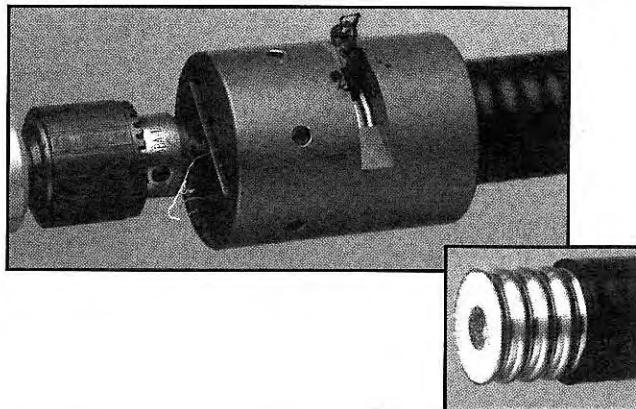

Notes:

L6PDF-RPC
L7PDF-RPC

Note:

The cable may also be manually prepared by using an EASIAx PLUS® Cable Prep Tool (Andrew CPTV2-114 for L6PDF-RPC or CPTV2-158 for L7PDF-RPC) as shown here.

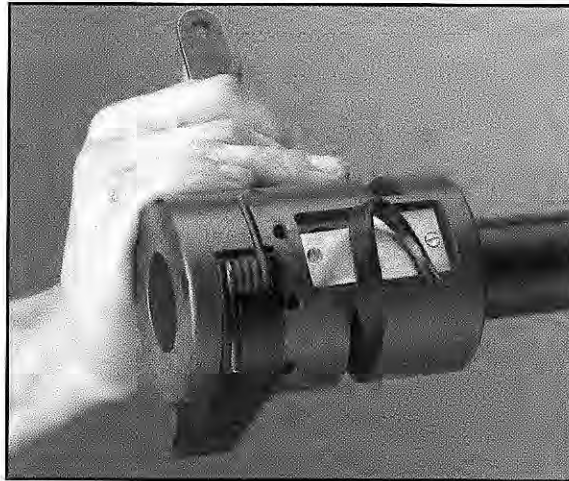

2

Remove the sharp edge from the inner conductor with the tip of a knife.

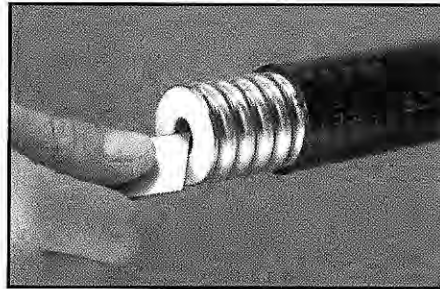

3

Separate the foam from the outer conductor with a knife by pressing the foam toward the inner conductor. This provides for entry of the flaring edge within the interface body. *Inspect the outer conductor to ensure it is in its original round and undistorted shape.*

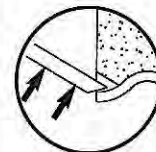
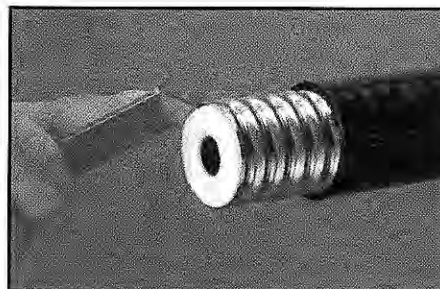

Note:

Step 3 may also be accomplished in one operation using the Foam Separation Tool provided with the connector or (Andrew FST-114 for L6PDF-RPC or FST-158 for L7PDF-RPC).

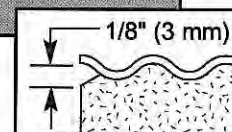
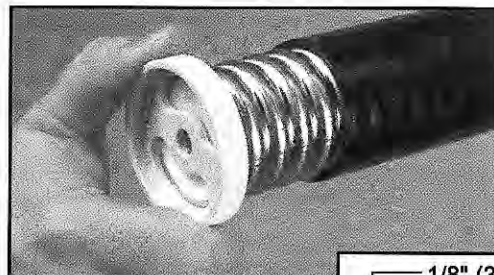

4

Screw the clamping body into the connector body one half turn to ensure that the threads are engaged.

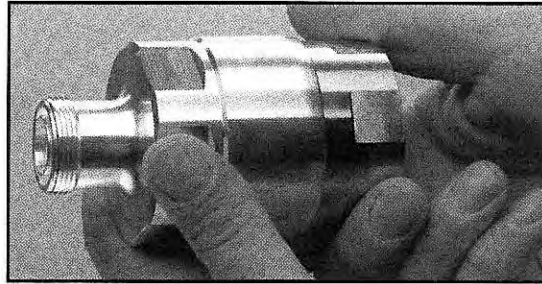

5

Push the connector assembly all the way onto the cable. *All gaskets are preinstalled and do not require lubrication.*

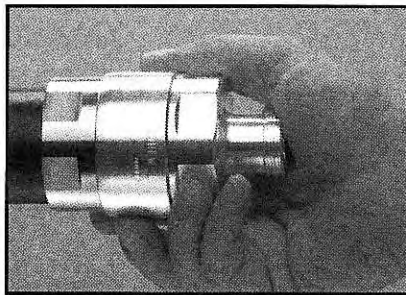

6

Screw the clamping body fully into the connector while pushing on the connector end. Then try to pull the connector assembly off the cable. If the connection remains secure, the attachment was done correctly.

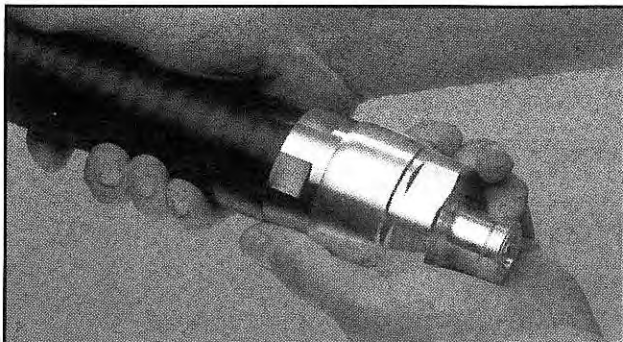
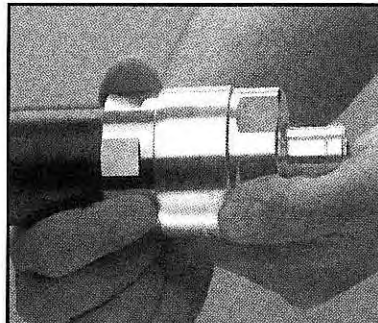

Notes:

7

For L6PDF-RPC tighten the connection with a torque wrench (Andrew 247698) to a value from 22 to 26 lbf·ft (30 to 35 N·m).

For L7PDF-RPC tighten the connection with a torque wrench (Andrew 244374) to a value from 30 to 34 lbf·ft (45 to 50 N·m).

Make sure you hold the connector body stationary with a wrench and rotate only the clamping body.

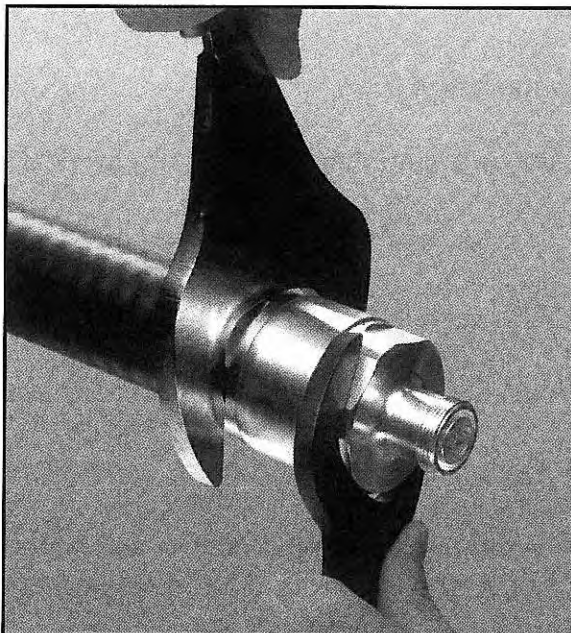

Notes:

Connector 8 L7PDF-RC Connector for LDF7 (1-5/8") Foam-dielectric Cable

Installation Tips

- Always straighten a minimum of 12" (300 mm) of the cable end.
- Use an accurate scale for all measurements.
- Use a knife to remove the cable jacket, but do not score the outer conductor.
- Apply silicone grease with a brush, not with your fingers.
- Deburr the inner and outer conductors using a file or knife.
- When tightening the connection with wrenches, hold the interface assembly stationary and rotate the clamping body according to the torque specified.

1

Straighten the last 12" (300 mm) of cable. Remove 2" (51 mm) of cable jacket by first cutting around the outer conductor. Then slice through the jacket along the outer conductor and peel off the jacket. Deburr the conductor.

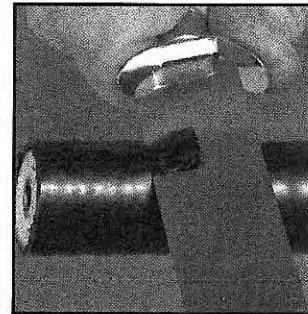
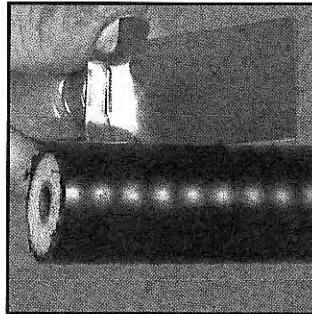

Note:

The cable can be fully prepared by using an EASIAx PLUS® Cable Prep Tool (Andrew CPT-158U) as shown here.

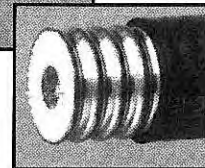
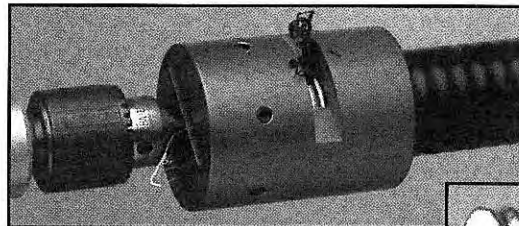

Notes:

Note:

The cable may also be manually prepared by using an EASIAx PLUS® Cable Prep Tool (Andrew CPTV2-158) as shown here.

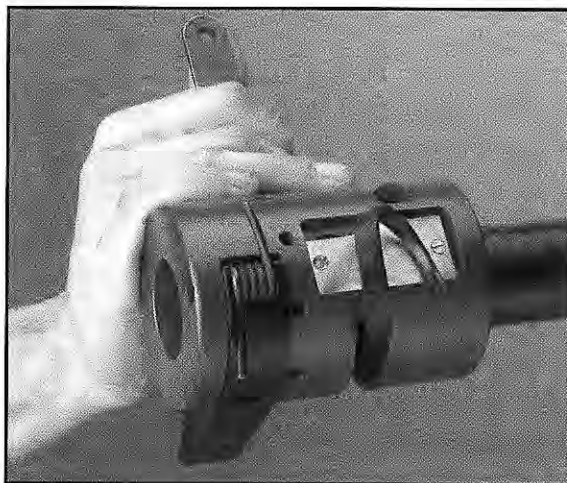
**2**

Place the small O-ring in the second corrugation valley from the edge of the jacket. Apply silicone grease to the O-ring. Push the unthreaded end of the clamping body onto the cable to expose two corrugation valleys.

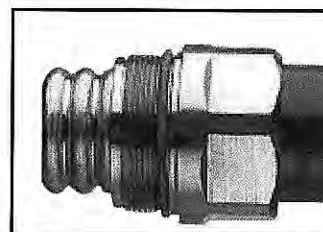
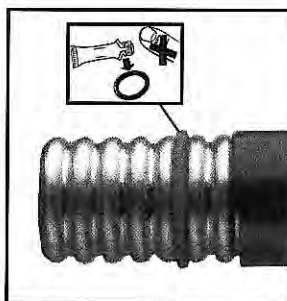
**3**

Place the spring ring into the first corrugation valley from the clamping body with care to avoid damaging the ring.

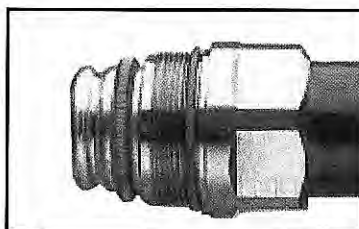
**4**

Position the saw guide against the spring ring and saw off the end of the cable flush with the guide.

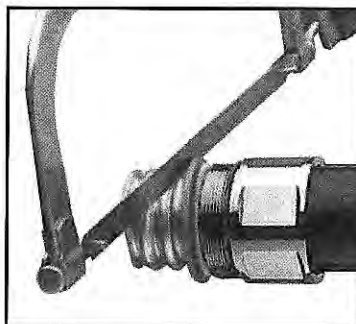
**Notes:**

5

Remove burrs from the outer and inner conductors with a file or the tip of a knife.

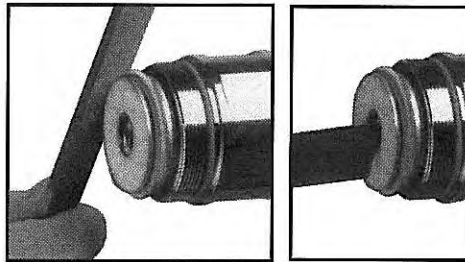

6

Remove any copper particles from the foam with a wire or nylon brush. *Such particles cause unwanted reflections of RF energy.*

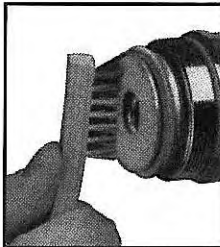

7

Start separation of the foam from the outer conductor with a knife tip by pressing the foam toward the inner conductor all the way around. This provides for entry of the flaring edge within the interface body. *Use the sticky side of a piece of electrical tape to remove hidden copper particles from the foam.*

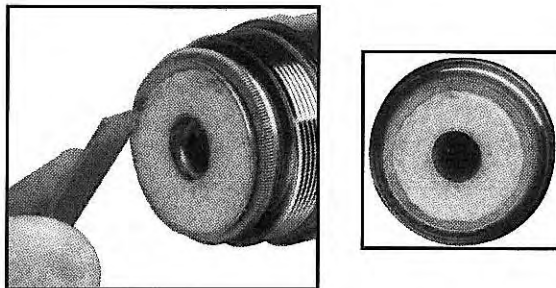

Note:

Step 7 may also be accomplished in one operation using the Foam Separation Tool. This provides for entry of the flaring edge within the interface body. *Inspect the outer conductor to ensure it is in its original round and undistorted shape.*

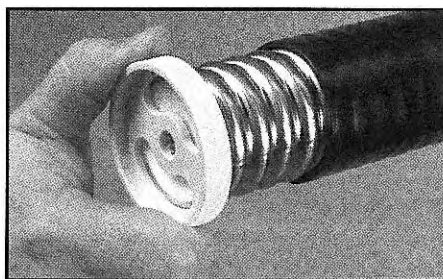

Notes:

8

Carefully guide the spring fingers of the inner contact into the inner conductor of the cable. Tighten the connection with a torque wrench (Andrew 244374) to a value of 33 to 37 lbf·ft (45 to 50 N·m). *Make sure you hold the interface assembly with a wrench (Andrew 244459-7) stationary and rotate only the clamping body.*

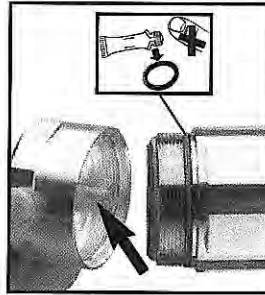
**9**

Disassemble the connector and inspect the flared outer conductor. It should be free of debris such as bits of foam and copper particles. Remove debris with a wire or nylon brush. Pull away any foam clinging to the outer conductor and press it toward the inner conductor.

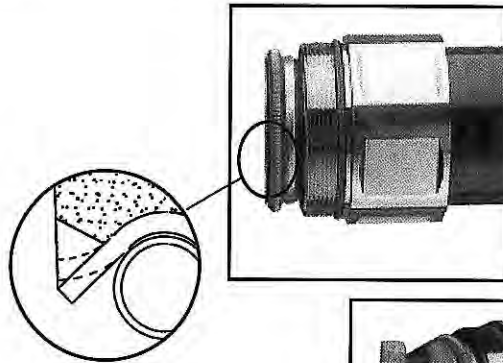
**10**

Reassemble the connector and tighten the connection with a torque wrench (Andrew 244374) to a value of 33 to 37 lbf·ft (45 to 50 N·m). *Make sure you hold the interface assembly with a wrench (Andrew 244459-7) stationary and rotate only the clamping body.*

**Notes:**

Connector 9 A7TDF-PS Connector for AVA7 (1 5/8") Foam-dielectric Cable

Installation Tips

- Always straighten a minimum of 12" (300 mm) of the cable end.
- Use an accurate scale for all measurements.
- If using a knife to remove the cable jacket, be careful not to score the outer conductor.
- Inspect the inner and outer conductors for burrs after prepping cable.
- When tightening the connection with wrenches, hold the interface assembly stationary and rotate the clamping body.

1

Straighten the last 12" (300 mm) of cable.

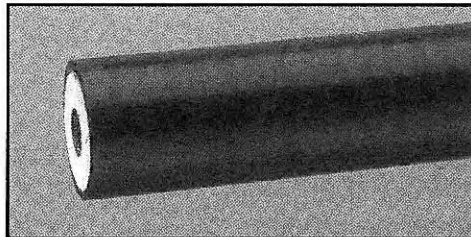

2

The cable may be manually prepared by using an EASIAx PLUS® Cable Prep Tool (Andrew CPTV2-158) as shown here. *Jacket removal blade should be located in the "RC" position.*

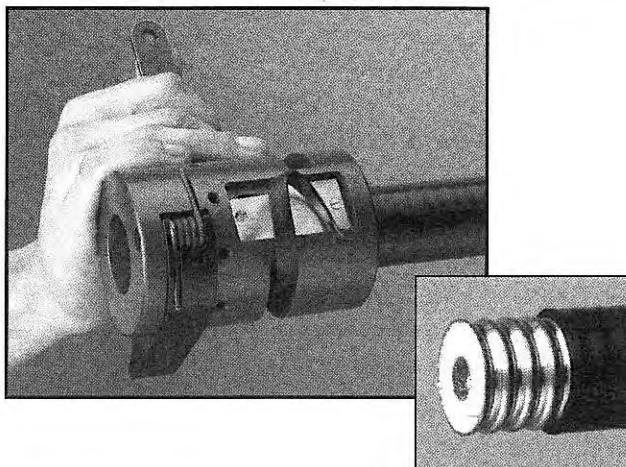

Notes:

2a

The cable may also be prepared by using an EASIAx PLUS® Cable Prep Tool (Andrew CPT-158U) as shown here. *Jacket removal blade should be located in the "RC" position.*

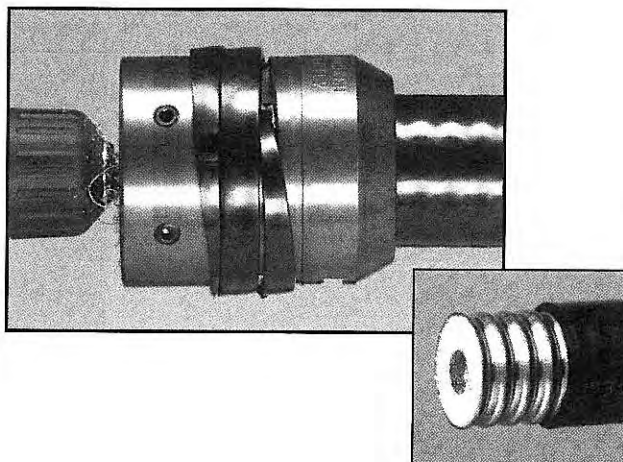

3

Separate the foam from the outer conductor in one operation using the Foam Separation Tool provided with the connector. This provides for entry of the flaring edge within the interface body. *Inspect the outer conductor to ensure it is in its original round and undistorted shape.*

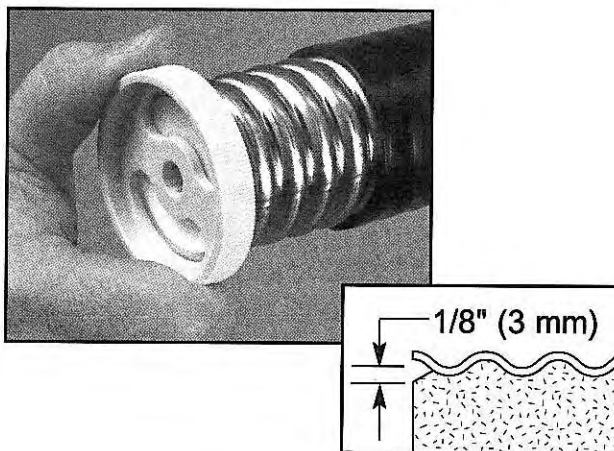

4

Push the unthreaded end of the clamping body onto the cable to expose one corrugation valley.

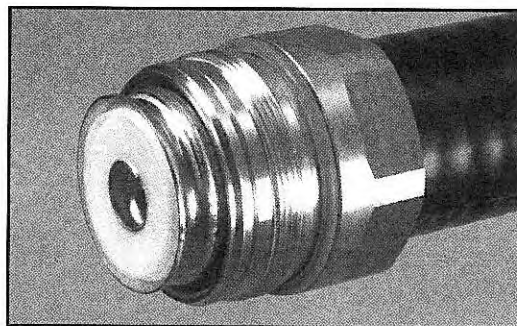

Notes:

5

Place the spring ring into exposed corrugation valley with care to avoid damaging the ring.

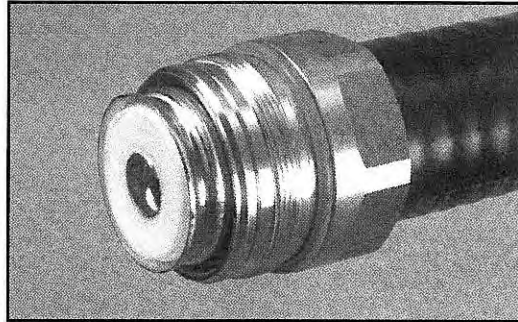

6

Carefully guide the spring fingers of the inner contact into the inner conductor of the cable. It will take less than 3/4 rotation to fully tighten the connection. *Make sure you hold the interface assembly with a wrench stationary and rotate only the clamping body. No gap should be present between clamping body and interface assembly.*

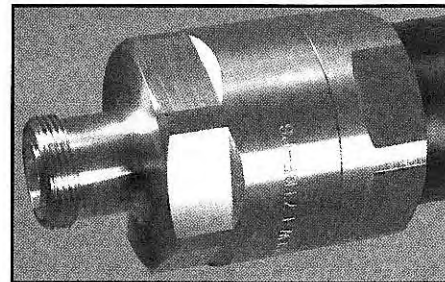
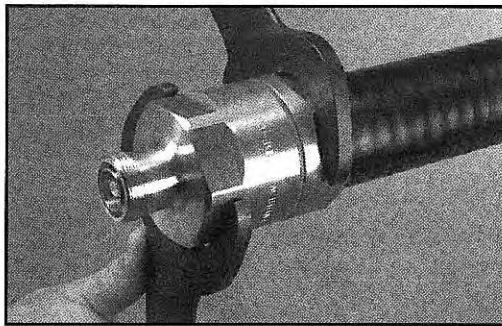

Notes:

Connector 10

152SE Connector for EW52 Elliptical Waveguide

Installation Tips

- Always straighten a minimum of 12" (300 mm) of the waveguide end.
- Use an accurate scale for all measurements.
- Use a knife to remove the waveguide jacket, but do not score the conductor.
- Apply silicone grease with a brush, not with your fingers.
- Use wire snips for tab flaring of the conductor.
- Use a beveled hammer to flare and flatten tabs.
- Deburr the conductor using a file or knife.
- Tighten the flange bolts in a criss-cross pattern.

1

Straighten the last 12" (300 mm) of waveguide. Saw the end of the waveguide off as square as possible. Remove loose copper debris by holding the waveguide downward and tapping the underside.



2

Remove 1-3/4" (44 mm) of jacket by first cutting around the waveguide. Use the straight edge of a sheet of paper wrapped around the waveguide as a cutting guide. Slice the jacket along its length and peel it off the waveguide.

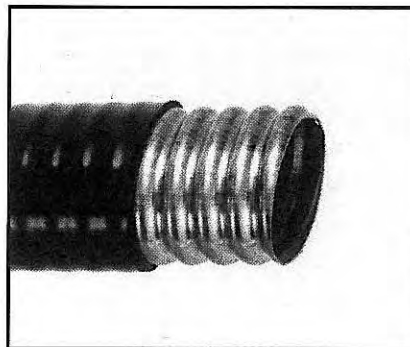

3

Slide the compression ring onto the waveguide.

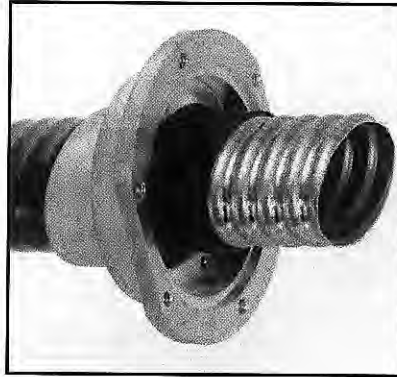

4

Stretch the wide gasket and slide it onto the waveguide close to the jacket.

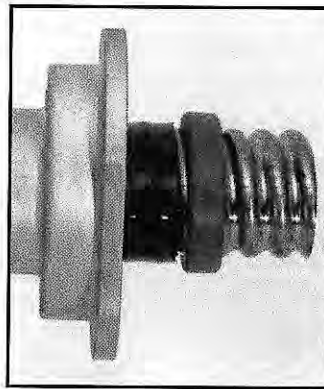

5

Pull the flare ring apart and slide it onto the waveguide until it seats in the corrugations closest to the gasket. Screw the gasket towards the flare ring until there is no gap. This will provide for a proper weatherproof seal. Make sure that the dimple in the flare ring is opposite the seam weld in the waveguide as shown by the arrows.

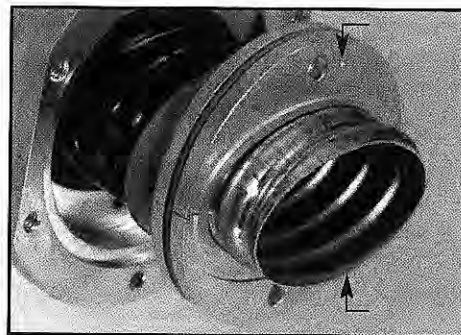

Notes:

6

Apply a thin coat of silicone grease to the gasket. Then, screw the flare ring to the compression ring, alternately tightening the screws a little at a time.

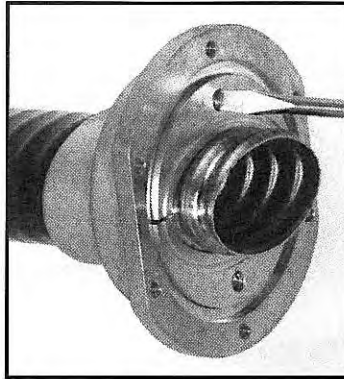

7

Place the saw guide firmly onto the compression ring. Hold the waveguide downward and saw through it. If the waveguide is not cut flush with the saw guide, use a file to file the waveguide flush.

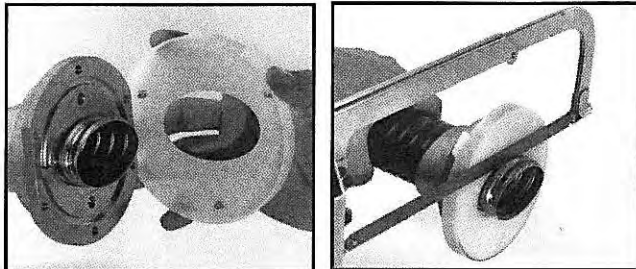

8

Remove any burrs with a file. *Do not scratch or otherwise damage the corrugations on the inside of the waveguide.*

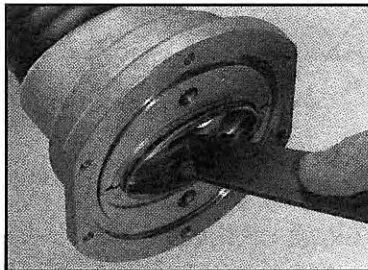

9

Cut the waveguide at 3/16" (5 mm) intervals to form tabs. *For better overall performance, cut only halfway to the flare ring.*

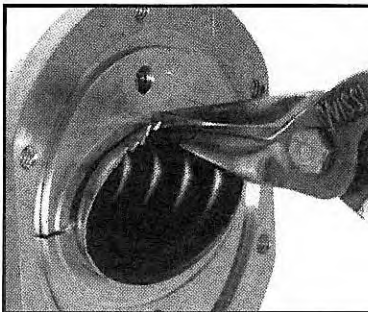

Notes:

10

Tap the inside surface of the waveguide against the inside edge of the flare ring with a plastic mallet (224392) or a tapered drift punch (Andrew 224358). Continue tapping outward so that the tabs are flattened against the face of the flare ring.

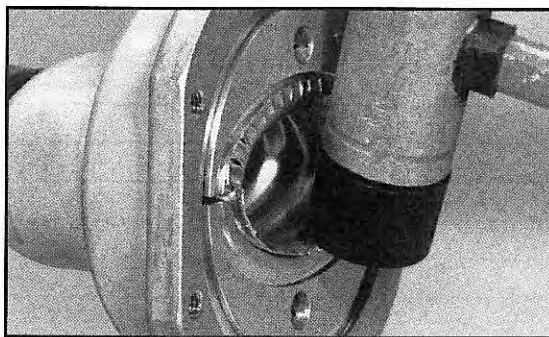
**11**

Trim conductor tabs that extend beyond the edge of the corresponding groove in the flare ring using wire snips (Andrew 224353). *Excessively long tabs will affect weatherproofing of the connector. Also, feel the corrugations within the waveguide for high spots which may have resulted from tab flaring. If so, remove the connector and start again at Step 1.*

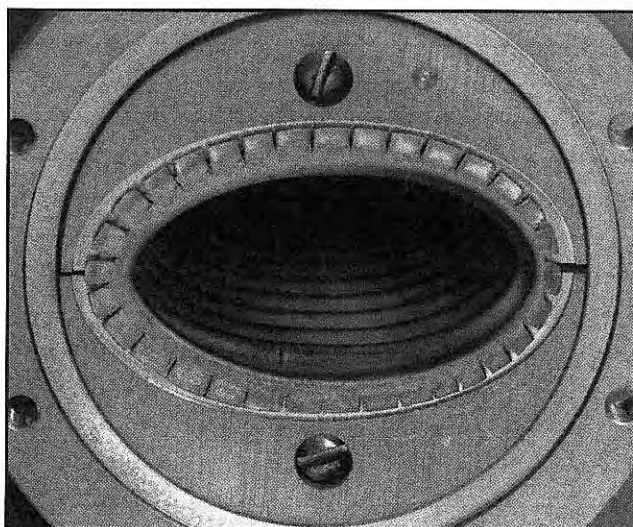
**12**

Place the O-ring in the large groove of the flare ring and attach the outer body to the compression ring with screws and lock washers. *Do not use silicone grease on this gasket.*

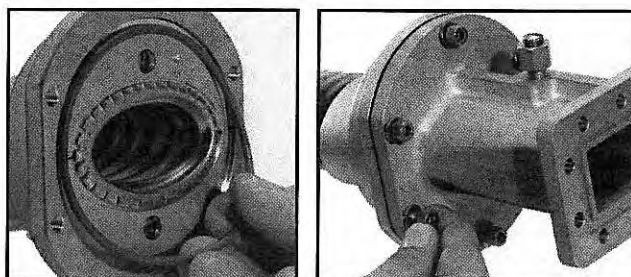
**13**

Tighten the screws in a criss-cross pattern as shown by the numbered pairs. *Make sure to provide a uniform gap between the connector flanges.*

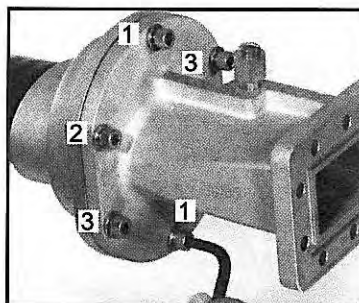

Accessories

Accessory 1 - Weatherproofing Kit for Connectors and Antennas

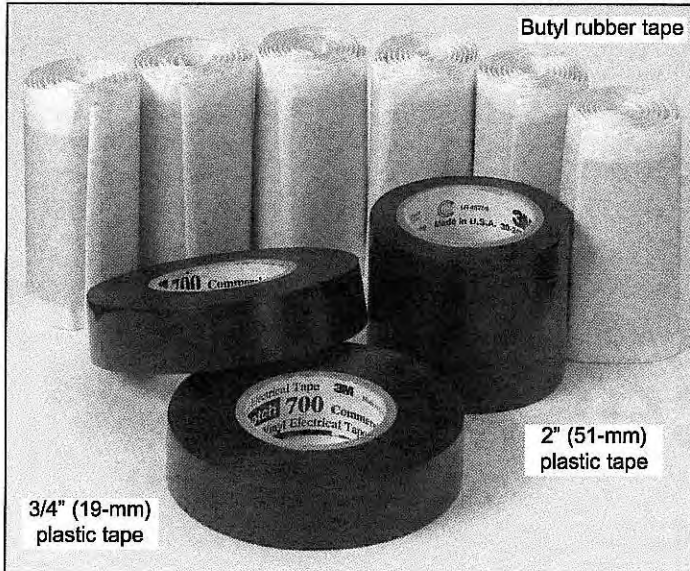

The kit can be used for one or more connections depending on the configuration and cable type as follows:

Connection type	Cable diameter	Connections per kit
LDF12 (2-1/4") to LDF4 (1/2")	2-1/4" to 1/2" (57 mm to 13 mm)	2
LDF7/VXL7 (1-5/8" to LDF4 (1/2")	1-5/8" to 1/2" (41 mm to 13 mm)	2
LDF6/VXL6 (1-1/4" to LDF4 (1/2")	1-1/4" to 1/2" (32 mm to 13 mm)	2
LDF5/VXL5 (7/8" to LDF4 (1/2")	7/8" to 1/2" (22 mm to 13 mm)	4
LDF4 (1/2") to LDF4 (1/2")	1/2" to 1/2" (13 mm to 13 mm)	6
VXL5 (7/8") to Device	7/8" to 1/2" (22 mm to 13 mm)	6
LDF4 (1/2") to Device	1/2" to 1/2" (13 mm to 13 mm)	6

Introduction

The application of sealing materials to antenna cable connections protects them from weather conditions. These include moisture penetration and loosening of connections from vibrations caused by strong winds.

Andrew Corporation recommends weatherproofing these connections according to the following procedures. Standard weatherproofing tapes, both butyl and plastic electrical tapes, are applied to the following:

- main feeder cable-to-jumper cable connection and
- jumper cable-to-antenna connection.

Become thoroughly familiar with and apply the Installation Tips given here.

Description

The use of this kit provides an additional moisture seal for cable connections. It also prevents loosening of connections from vibration or other external stresses which would eventually allow moisture penetration. The sealed connection is suitable for typical exposed and buried cable applications.

Installation Tips

- When applied, the tape must be above 32°F (0°C) to ensure adhesion. Keep tape warm by carrying in coat pockets.
- Do not stretch the tape. Apply only enough tension to provide a smooth wrap.
- Smooth each wrapped layer with your hands to ensure full adhesion.
- Do not pull the tape to tear it - always cut it. Pulled tape eventually unravels, decreasing protection.
- Add extra final layers of tape in warmer climates where there will be long exposure to damaging ultra violet (UV) rays. Two or three extra layers of tape will provide additional UV protection.
- On vertical runs, the last wrap of 3/4" tape should be wrapped from the bottom to the top. This provides a shingle effect.
- When wrapping tape, overlap the tape to half-width as shown here.

Tape overlap

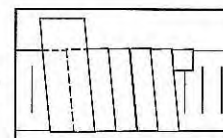

Weatherproofing Kit

Feeder Cable to Jumper Cable Connection

1 Tighten the connection with a torque wrench to the proper torque value to ensure that correct internal seals and surface contacts are made.

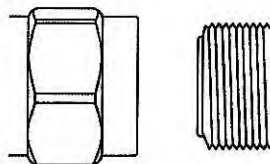

Connector coupling

Torque wrench	Connector type	Torque
Andrew 244377	7-16 DIN	18 - 22 lb·ft
Andrew 244379	N	15 - 25 lb·in

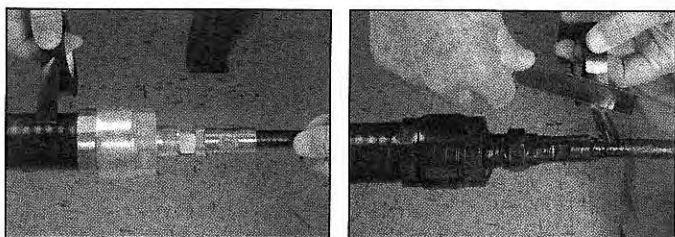

Plastic tape wrap

2 Prepare the cable by removing any cable markers and drying the cable and connectors. Starting at 2" (51 mm) from the feeder connector, wrap the connection with a layer of 3/4" (19-mm) plastic tape. Overlap the tape to half-width and extend the wrapping 2" (51 mm) beyond the jumper connector or plastic strain relief of a SureFlex™ jumper. **Note: Do not remove the jumper strain relief.**

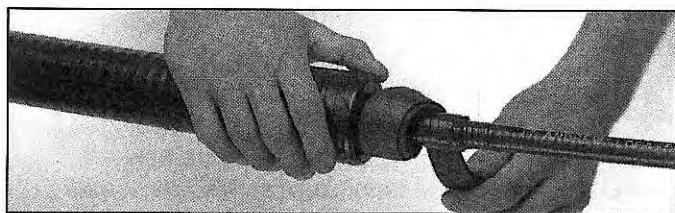

End of 2" plastic tape wrap

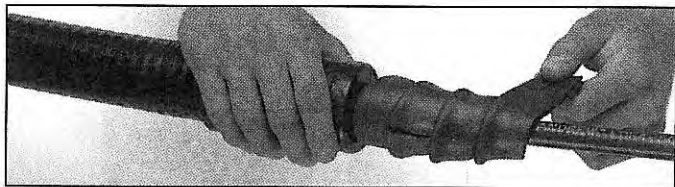

Start of 3/4" plastic tape wrap

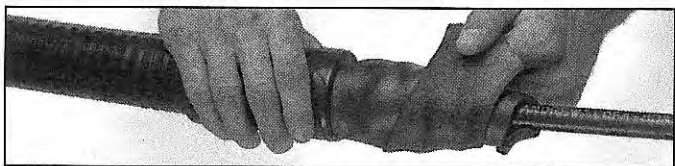

Rubber tape fill

3 Cut the rubber tape into three 12" (305-mm) lengths for 2-1/4" (57-mm), 1-5/8" (41-mm), and 1-1/4" (32-mm) to 1/2" (13-mm) connections.

For 7/8" (22-mm) to 1/2" (13-mm) connections, cut three 4" (102-mm) lengths of tape.

Form a tapered surface by starting with two tapes that are folded to half-width and finishing with one full-width tape.

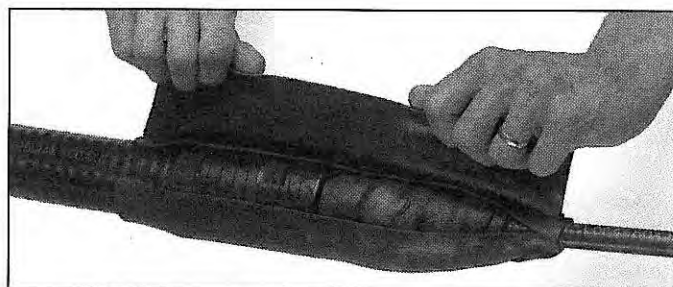

Rubber tape wrap

4 Cut the rubber tape into three 12" (305-mm) lengths for 2-1/4" (57-mm), 1-5/8" (41-mm), and 1-1/4" (32-mm) to 1/2" (13-mm) connections. For 7/8" (22-mm) to 1/2" (13-mm) connections, cut three 8" (203-mm) lengths of tape. For 1/2" (13-mm) to 1/2" (13-mm) connections, cut three 8" (203-mm) lengths of tape.

Lay the three rubber tapes around the entire connection so that they overlap. Pull the tape as needed for overlap. Press the tapes together along the overlaps.

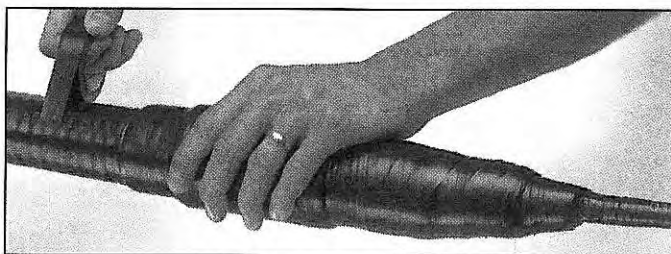
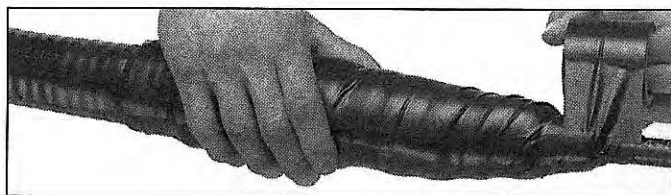

5 Wrap the connection with a layer of the 2" (51 mm) tape and then three continuous layers the 3/4" (19 mm) plastic tape. Overlap each tape to half-width and extend the wrapping 2" (51 mm) beyond the previous tape.

Jumper Cable to Antenna Connection

Due to the variability in design of base station antennas at the point of connector interface, special attention must be given to the application of weatherproofing materials. The following illustrations demonstrate the recommendations of Andrew Corporation in cases where there is ample access to the connection and where access is restricted.

Ample Access

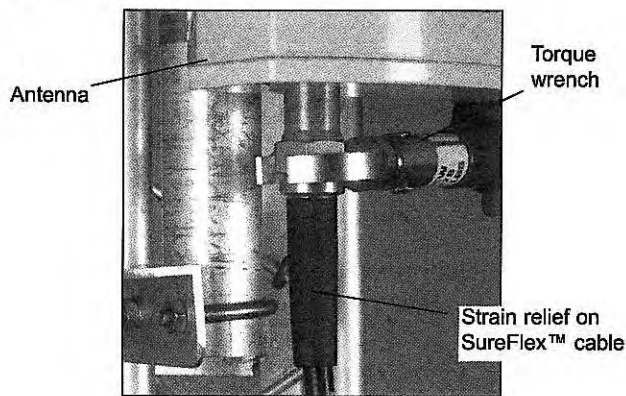

Tighten connection

1 Tighten the connection with a torque wrench to the proper torque value to ensure that correct internal seals and surface contacts are made.

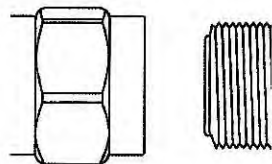

Torque wrench	Connector type	Torque
Andrew 244377	7-16 DIN	18 - 22 lb-ft
Andrew 244379	N	15 - 25 lb-in

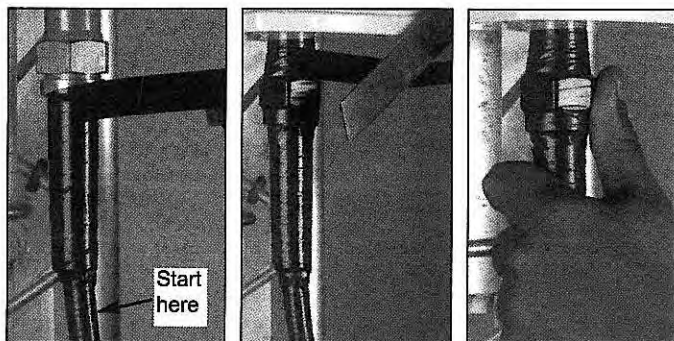

Plastic wrap

Cut

Smooth

2 Wrap the connection with a layer of 3/4" (19-mm) plastic tape, starting at 1" (25 mm) from the connector or plastic strain relief of a SureFlex™ jumper. Overlap the tape to half-width and extend the wrapping to the flange of the antenna connector. Avoid making creases or wrinkles. Smooth the tape edges.

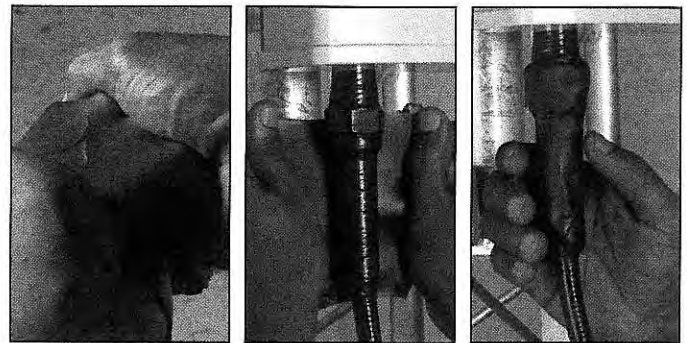

Stretch rubber

Wrap

Smooth

3 Cut an 5" (125-mm) length of rubber tape. Expand the width of the tape by stretching it so that it will wrap completely around the connector and cable. Wrap the tape around the cable connector and the cable. Press the tape edges together so that there are no gaps. Press the tape against the connection and cable. The tape should extend 1" (25 mm) beyond the plastic tape on the jumper.

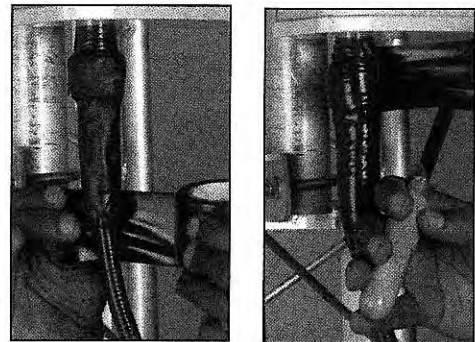

Plastic wrap

Cut

4 Start wrapping a layer of 2" (50-mm) plastic tape 1" (25 mm) below the rubber tape, overlapping at half width. Finish the wrap at the flange of the antenna connector and cut the tape. Repeat this process for second layer.

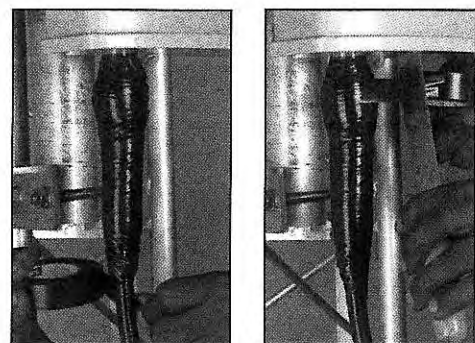

Plastic wrap

Cut

5 Start wrapping three layers of 3/4" (19-mm) plastic tape 1" (25 mm) below the previous 2" (50-mm) wrap, overlapping at half width.

Weatherproofing Kit

Restricted Access

Where access to the antenna connector and jumper cable will be restricted for taping, most of the jumper cable must be prepared before it is connected.

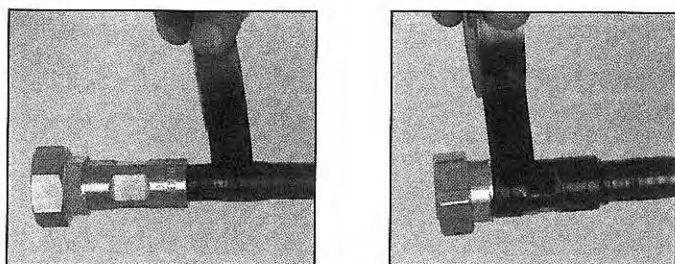

Plastic wrap

1 Wrap the cable and connector body with a layer of 3/4" (19-mm) plastic tape, starting at 1" (25 mm) from the connector body. Overlap the tape to half-width. *Do not tape the connector clamping nut.* Avoid making creases or wrinkles. Smooth the tape edges.

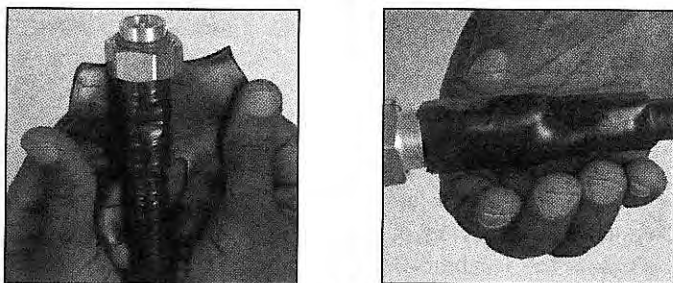

Rubber wrap

2 Cut a 3-1/2" (90-mm) length of rubber tape. Expand the width of the tape by stretching it so that it will wrap completely around the connector body and cable. Wrap the tape around the cable connector body and the cable. *Do not tape the connector clamping nut.* Press the tape edges together so that there are no gaps. Press the tape against the connector body and cable. The tape should extend 1" (25 mm) beyond the plastic tape on the jumper.

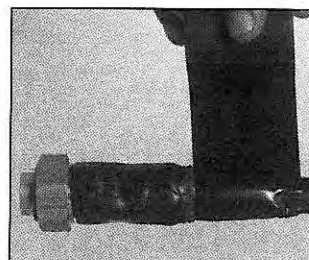

Plastic wrap

3 Start wrapping a layer of 2" (50-mm) plastic tape 1" (25 mm) beyond the rubber tape, overlapping at half width. Finish the wrap at the connector clamping nut and cut the tape. Repeat this process for a second layer.

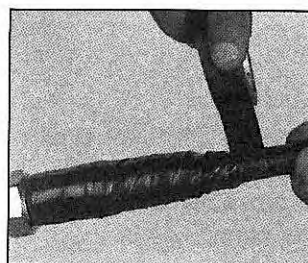

Plastic wrap

4 Start wrapping a layer of 3/4" (19-mm) plastic tape 1" (25 mm) beyond the 2" (50-mm) tape, overlapping at half width. Finish the wrap at the connector clamping nut and cut the tape. Repeat this process for a second layer and a third layer.

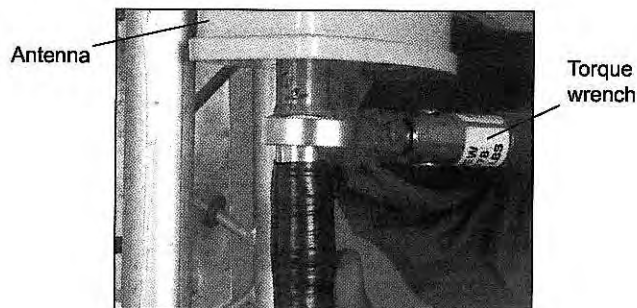
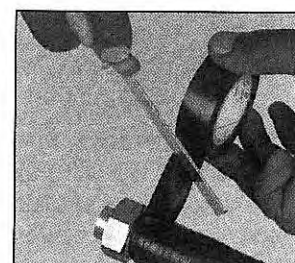

Tighten connection

5 Connect the jumper cable to the antenna connector. Tighten the connection with a torque wrench to the proper torque value to ensure that correct internal seals and surface contacts are made.

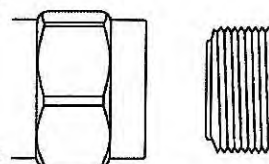

Connector coupling

Torque wrench	Connector type	Torque
Andrew 244377	7-16 DIN	18 - 22 lb-ft
Andrew 244379	N	15 - 25 lb-in

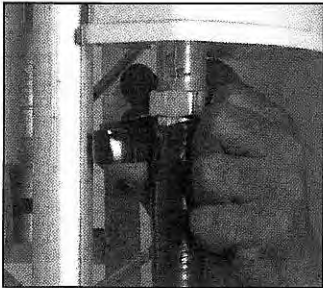

Hold roll and push tape

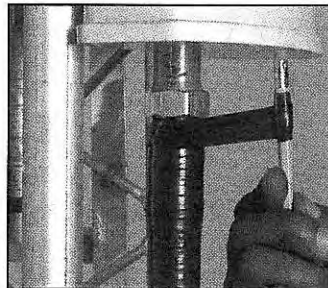

Uncoil tape from pencil

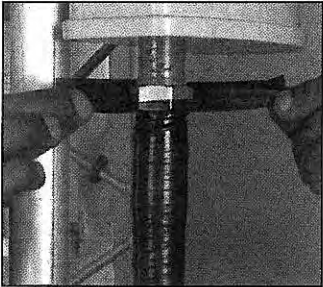

Apply tape in strips

6 Start wrapping three layers of 3/4" (19-mm) plastic tape 1" (25 mm) at the connector clamping nut, overlapping at half width. The tape should extend 1" (25 mm) beyond the cable connector clamping nut.

The tape can be applied in one or more strips if necessary. A strip can be coiled onto an applicator such as a pencil. Apply only enough tension to get good adhesion and keep the tape smooth.

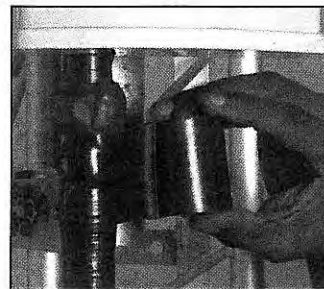

Apply wide tape



Apply narrow tape

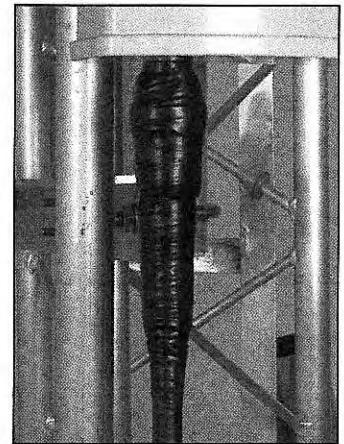

Completed wrapping

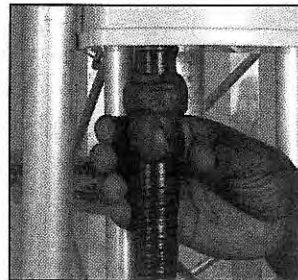
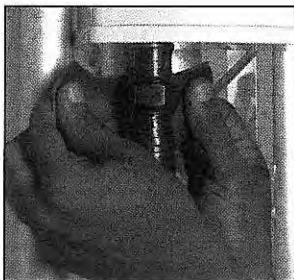

Rubber wrap

7 Cut a 2" (50-mm) length of rubber tape. Expand the width of the tape by stretching it so that it will wrap completely around the connector body and clamping nut. Wrap the tape around the cable connector. Press the tape edges together so that there are no gaps. Press the tape against the connector

8 Wrap two layers of 2" (50-mm) plastic tape and then three layers of 3/4" (19-mm) plastic tape to complete the wrapping. Start each wrap 1" (25 mm) from the previous wrap.

Note: When removing the weatherproofing from connections, take precautions to not cut through the jacket of the coaxial cable. If the jacket is cut, the rewinding should start at the point of the exposed copper outer conductor.

Andrew 221213 Weatherproofing Kit Components

Part number	Description
9905-41	3/4" x 66' black plastic tape
9905-71	2" x 20' black plastic tape
42615-10	Butyl rubber tape

WeatherShield™ Main Line/Jumper

1

Wipe the inside of the enclosure and all connections with a clean dry cloth. *This ensures the enclosure is moisture free. Any moisture sealed into the enclosure will remain inside.*

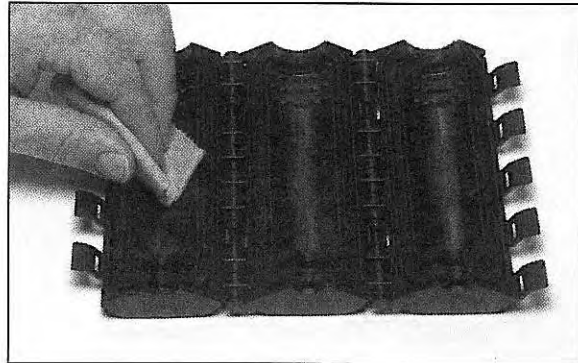

2

With your finger, apply a thin layer of grease to the gasket before sealing the enclosure. *This allows the enclosure to rotate freely, if required, during installation.*

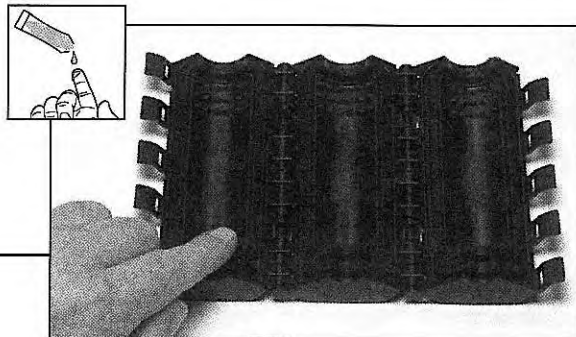

3

To ensure the seal is not compromised, be sure jumper assembly is straight within the length of the enclosure.

Position the center section of the enclosure so the clamping nut is gasket covers the antenna interface and the jumper assembly.

Next, fold the remaining sections of the enclosure around the antenna interface and jumper assembly.

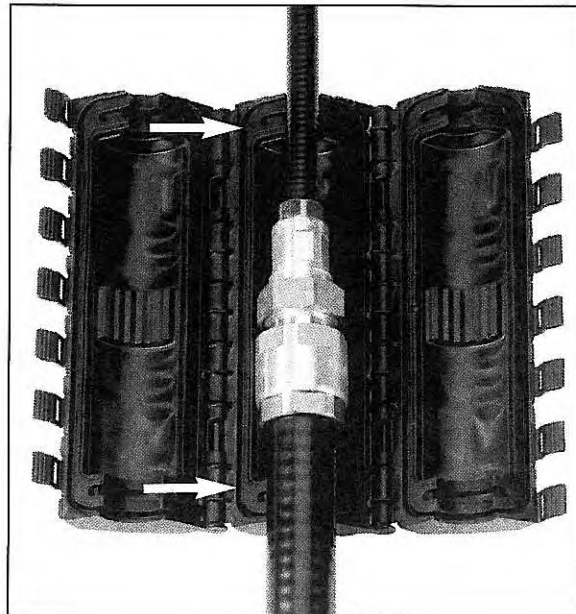

Notes:

4

Place your thumbs under the locking tabs and compress until you hear a click.

Continue up the enclosure, compressing each set of tabs, until the enclosure is fully sealed.

Note: Verify the top and bottom tabs are fully engaged.

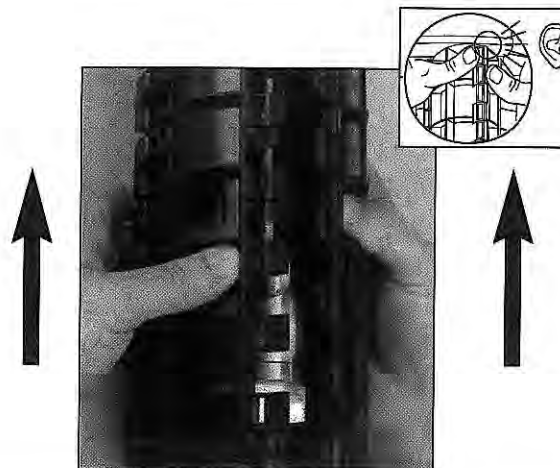

REMOVAL

Starting at the center of the enclosure, use your fingers to press the locking tabs towards each other. Continue working the enclosure until all locking tabs are disengaged. Open sides of enclosure and remove.

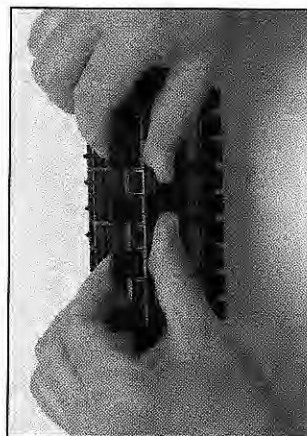

RESEALING

After initial installation, the enclosure can be re-entered and resealed. Before resealing, wipe the inside of the enclosure and all connections with a clean dry cloth.

With your finger, apply a thin layer of grease to the gasket before sealing the enclosure. *This allows the enclosure to rotate freely, if required, during installation.*

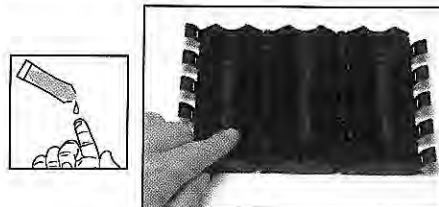
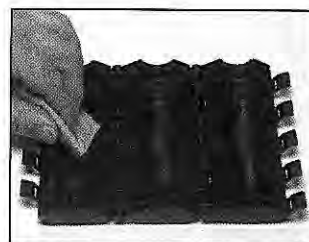

Notes:

WeatherShield™ Jumper/Antenna

1

Wipe the inside of the enclosure and all connections with a clean dry cloth. *This ensures the enclosure is moisture free. Any moisture sealed into the enclosure will remain inside.*

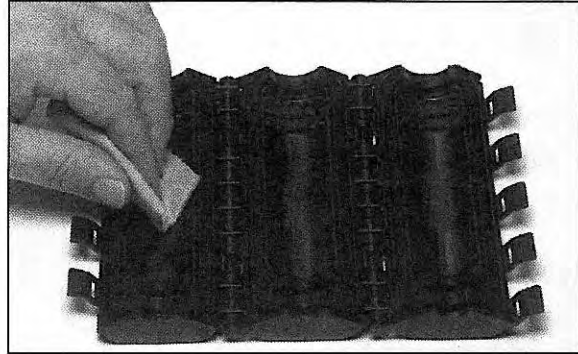

2

With your finger, apply a thin layer of grease to the gasket before sealing the enclosure. *This allows the enclosure to rotate freely, if required, during installation.*

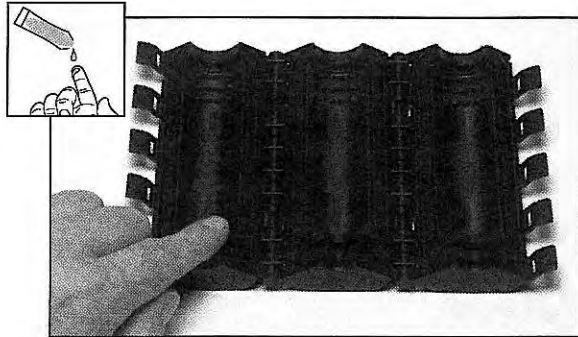

3

To ensure the seal is not compromised, be sure jumper assembly is straight within the length of the enclosure.

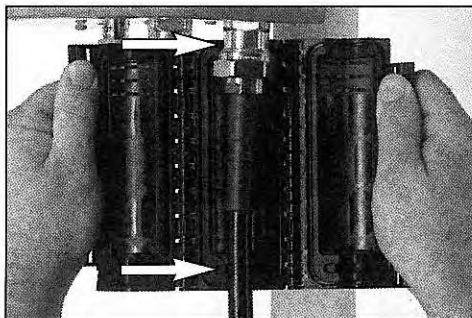

Position the center section of the enclosure so the gasket covers the antenna interface and the jumper assembly.

Next, fold the remaining sections of the enclosure around the antenna interface and jumper assembly.

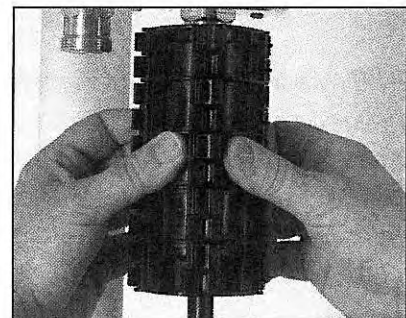

Notes:

4

At the bottom of the enclosure, place your thumbs under the locking tabs and compress until you hear a click.

Continue up the enclosure, compressing each set of tabs, until the enclosure is fully sealed.

Note: Verify the top tabs are fully engaged.

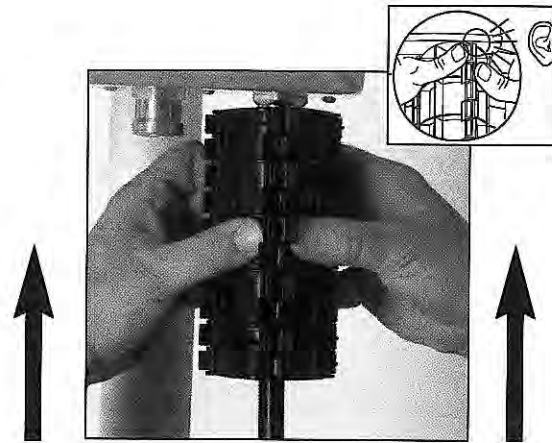

REMOVAL

Starting at the center of the enclosure, use your fingers to press the locking tabs towards each other. Continue working the enclosure until all locking tabs are disengaged. Open sides of enclosure and remove.

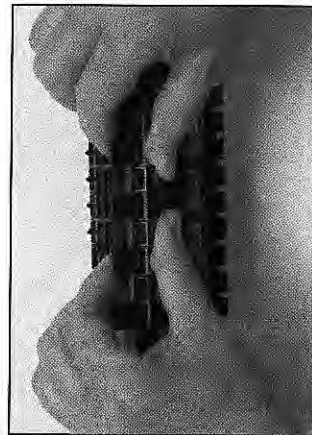

RESEALING

After initial installation, the enclosure can be re-entered and resealed. Before resealing, wipe the inside of the enclosure and all connections with a clean dry cloth.

With your finger, apply a thin layer of grease to the gasket before sealing the enclosure. *This allows the enclosure to rotate freely, if required, during installation.*

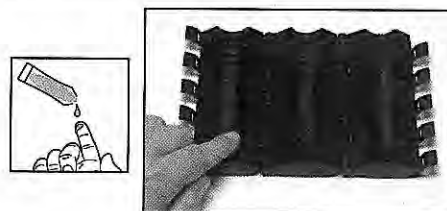
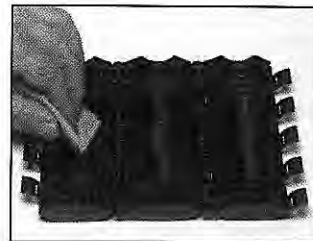

Notes:

Accessory 2 - SureGround™ and Compact SureGround™ Plus Version 2 Grounding Kits for HELIAX® LDF Coaxial Cable

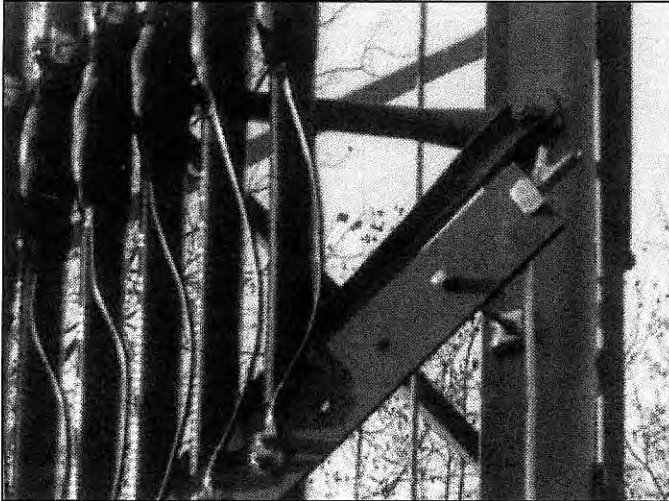

Description

These grounding kits are designed to provide electrical contact between the outer conductor of the HELIAX LDF Series coaxial cable and either a tower member or a separate conductor as a lightning path towards earth.

The HELIAX transmission line should be grounded along the vertical run near the top and bottom and at the entrance of the line into the equipment shelter. The midpoint of the vertical run of transmission line should also be grounded if the height of the line exceeds 200 feet (60 m).

Military Installations: Prepare the cable and ground strap surfaces per applicable sections of MIL-STD-188-124 and MIL-HDBK-419.

⚠ WARNING

Do not attempt grounding kit installation in the presence of thunderstorms. Failure to obey this warning may result in injury or death to you or to others.

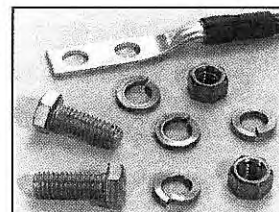
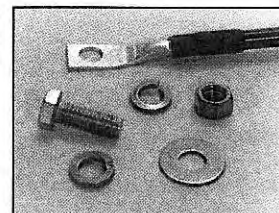
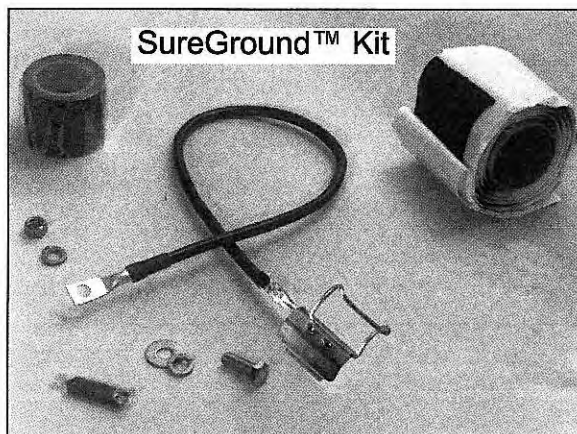
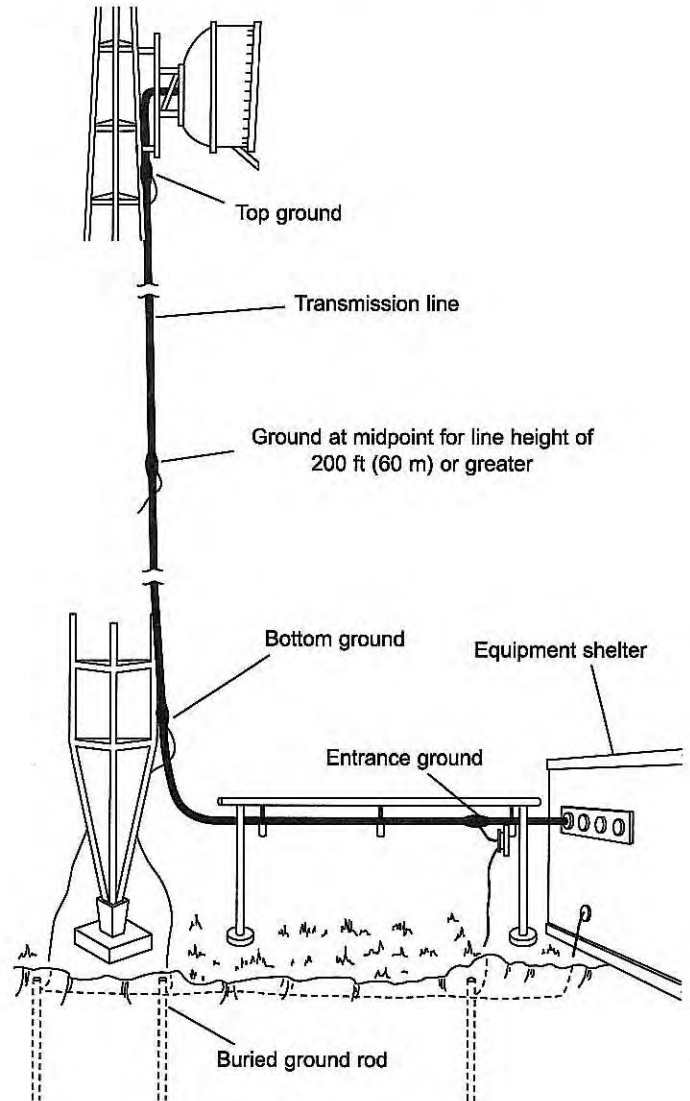

SureGround™ Grounding Kit

Installation Tips

- It is recommended that on vertical cable lengths greater than 200 feet (60 m) a ground connection should be made at mid-span.
- Make sure the ground wire is routed toward the earth.
- Always keep the ground wire as straight as possible.
- Never attach the ground clip over the cable jacket.
- Make sure the bail is pushed beyond the bulge in the clip to lock it in place.
- When applying butyl rubber tape, always start at the bottom of the ground area and wrap toward the top to eliminate points where water may build up.
- When wrapping over the butyl tape with electrical tape, start at the bottom and wrap toward the top, and then toward the bottom, finishing at the top using five layers of tape.
- Gently stretch the electrical tape during wrapping to eliminate wrinkles which can become channels where water could flow.
- Do not stretch the electrical tape during the last two turns of the fifth layer. Stretched tape will eventually come loose and create a "flag."
- Apply non-oxidizing grease (gray compound) between ground wire terminal and the point of attachment to prevent oxidation of these surfaces.
- The same rules that apply to tower installations also apply to rooftop installations. Make sure that the ground wire is directed away from the antenna.

Notes:

1

Loosely attach the ground wire terminal to the attachment point (bus bar, etc.). Then, position the ground clip on the cable and make a knife cut on both sides of the ground clip. Remove the jacket between the two cuts, being careful not to score the outer conductor.

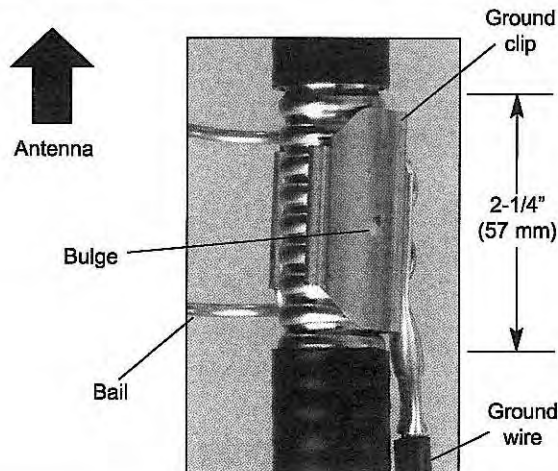

Note:

The cable may also be fully prepared using an Andrew grounding kit tool:

Cable	Tool
LDF4-50A	GKT-L4A
FSJ4-50B	GKT-F4
LDF5-50A	GKT-78A
VXL5-50	GKT-78A
AVA5-50	GKT-78A
LDF6-50	GKT-114A
LDF7-50A	GKT-158A
VXL7-50	GKT-158A
AVA7-50	GKT-158A

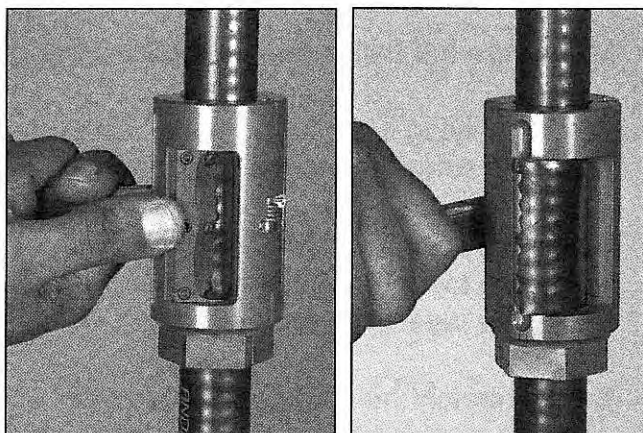

2

Cut off a piece of butyl rubber tape 1-1/2 inches (38 mm) long and wrap it around the ground wire, covering the exposed copper wire near the ground clip.

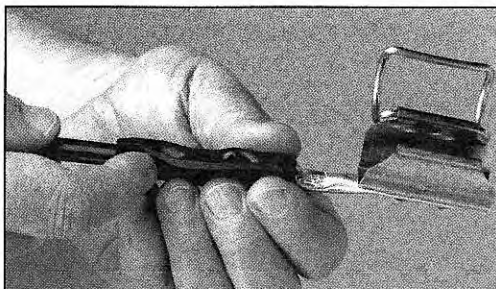

3

Push the ground clip onto the outer conductor and force the bail beyond the bulge of the clip to lock the clip in place.

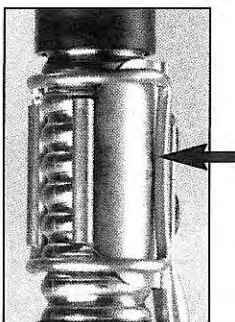

4

Press and form the butyl rubber tape on the ground wire to the jacket of the cable. *(This will ensure a good weather seal between the cable and the ground wire.)*

**5**

Starting at the bottom, wrap the butyl rubber tape over the entire connection in a half-width, overlapping pattern, slightly stretching the tape as you wrap. Continue upward to a point 3 to 4 inches (76 to 102 mm) above the bail. *(Make sure that the tape completely covers the connection.)* Squeeze the tape along its edges to form it to the connection.

**Notes:**

6

Wrap five layers of electrical tape over the entire connection so that each layer extends 1 inch (25 mm) beyond the ends of the previous layer. Start wrapping at the bottom, below the butyl rubber tape, and overlap the tape at half-width. (*Gently stretch the tape enough to avoid forming wrinkles.*) Reverse wrapping directions at the end of each layer. **DO NOT STRETCH THE TAPE FOR THE LAST TWO TURNS OF THE FIFTH LAYER** to avoid unraveling because of tension on the adhesive. Tightly squeeze the completed tape wrapping with both hands to ensure that the layers are secure.

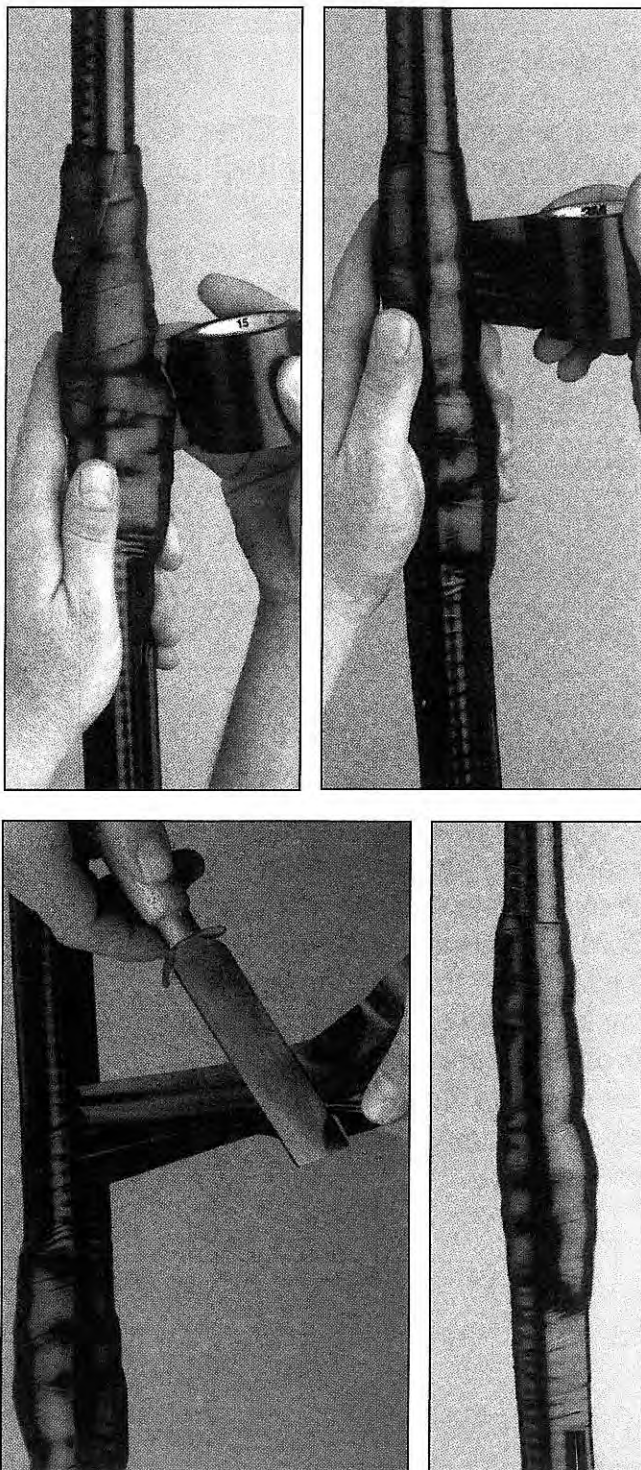

Notes:

Compact SureGround™ Plus Version 2 Grounding Kit

Installation Tips

- It is recommended that on vertical cable lengths greater than 200 feet (60 m) a ground connection should be made at mid-span.
- Make sure the ground wire is routed towards the earth.
- Always keep the ground wire as straight as possible.
- Never attach the contact surface area over the cable jacket.
- Apply non-oxidizing grease (gray compound) between ground wire terminal and the point of attachment to prevent oxidation of these surfaces.
- The same rules that apply to tower installations also apply to rooftop installations. Make sure that the ground wire is directed away from the antenna.

1

Remove 2-1/4" (57 mm) of jacket using a knife or a Andrew grounding kit tool:

Cable	Tool
LDF4-50A	GKT-L4A
FSJ4-50B	GKT-F4
LDF5-50A	GKT-78A
VXL5-50	GKT-78A
AVA5-50	GKT-78A
LDF6-50	GKT-114A
LDF7-50A	GKT-158A
VXL7-50	GKT-158A
AVA7-50	GKT-158A

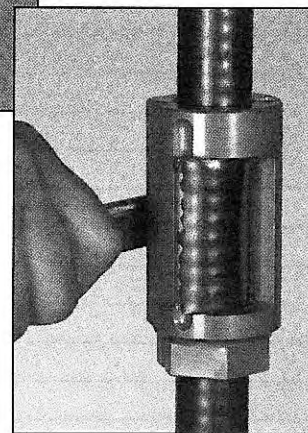
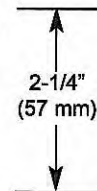
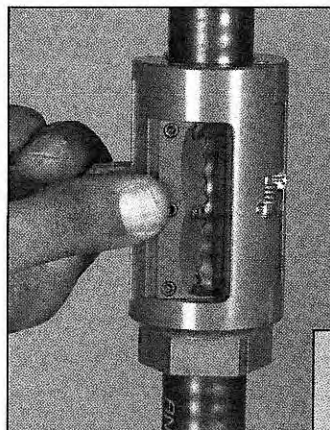

Notes:

Grounding Kit

2
Open housing and remove plastic film to expose butyl tape.

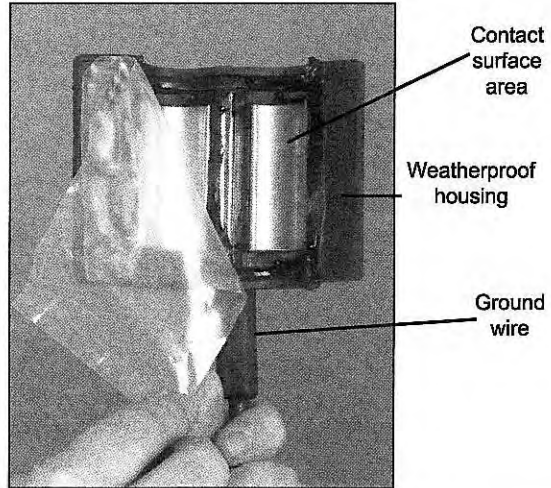

3
Position weatherproof housing and insure contact surface area is on the exposed corrugations. *Butyl rubber tape must be over jacketing for proper weather seal.*

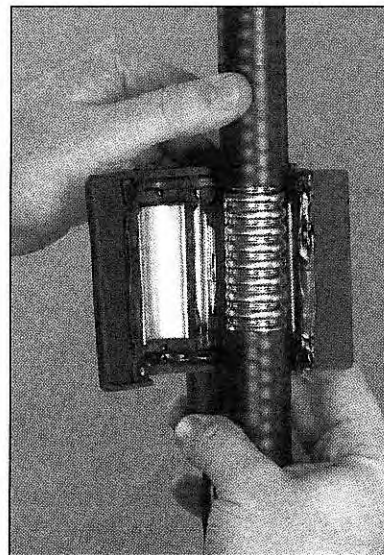

4
With continued pressure on housing position locking bail.

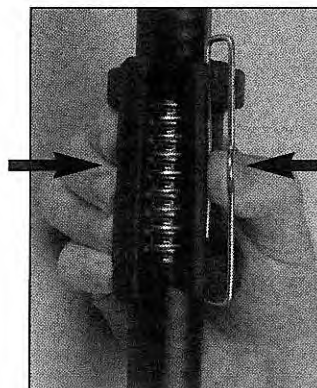

Notes:

5

With thumb on back side of bail close around the weatherproof housing with a flat blade screwdriver.

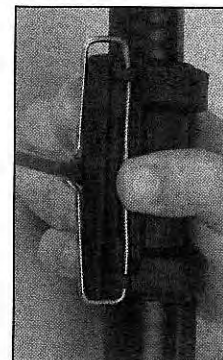
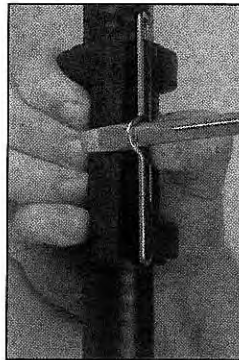

This will ensure a uniformed seal.

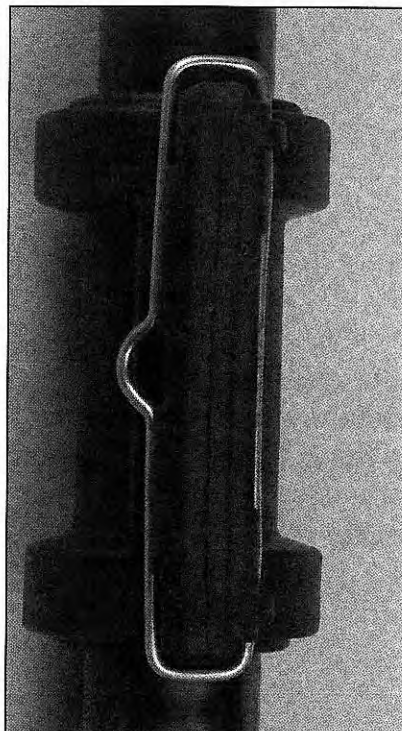

Inspect weatherproof housing, no gaps should be present along the seam and butyl tape should be visible between housing and the cable.

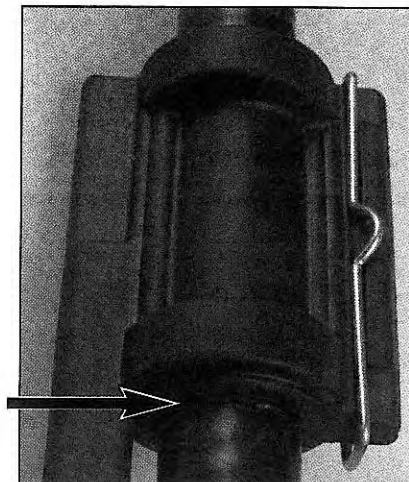

Notes:

Accessory 3 - Grounding Kit for HELIAX® Coaxial Cable and Elliptical Waveguide

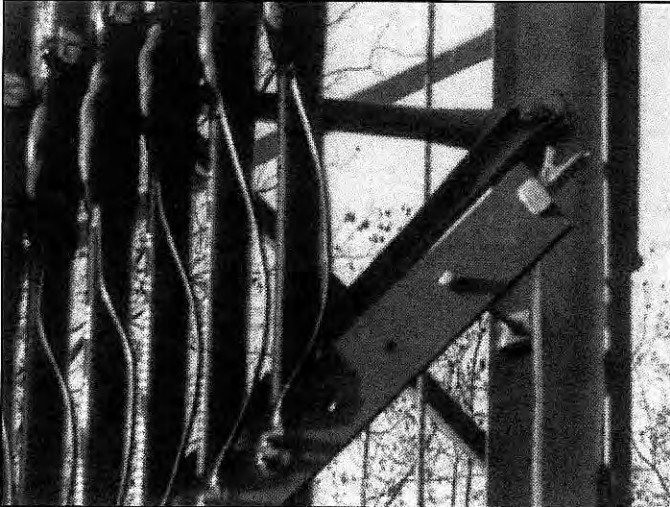

Description

This grounding kit is designed to provide electrical contact between the outer conductor of the HELIAX coaxial cable or elliptical waveguide and either a tower member or a separate conductor as a lightning path towards earth.

The HELIAX transmission line should be grounded along the vertical run near the top and bottom and at the entrance of the line into the equipment shelter. The midpoint of the vertical run of transmission line should also be grounded if the height of the line exceeds 200 feet (60 m).

Military Installations: Prepare the waveguide or cable and ground strap surfaces per applicable sections of MIL-STD-188-124 and MIL-HDBK-419.

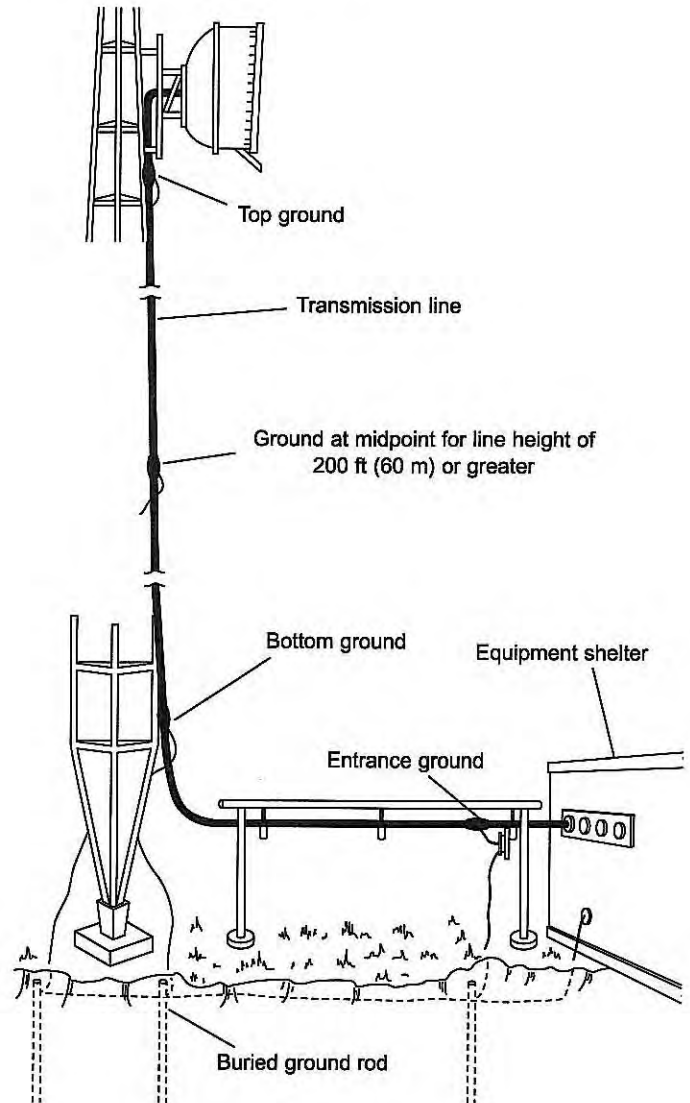

WARNING

Do not attempt grounding kit installation in the presence of thunderstorms. Failure to obey this warning may result in injury or death to you or to others.

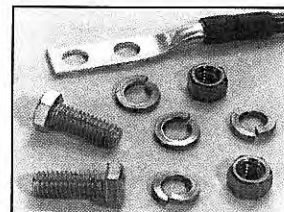
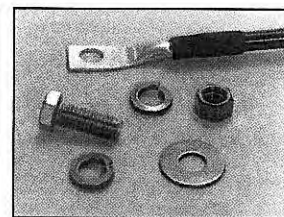
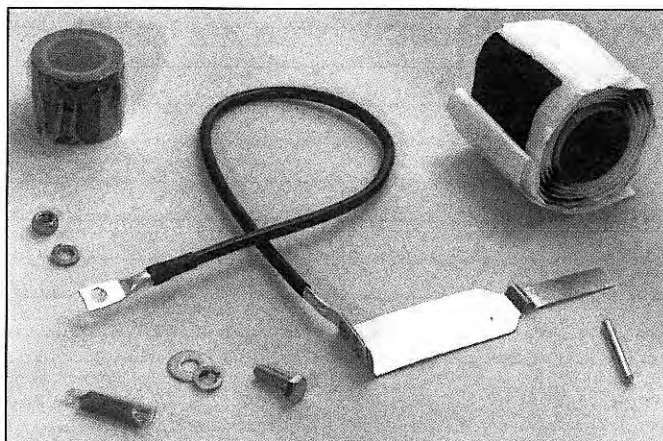

Installation Tips

- It is recommended that on vertical cable lengths greater than 200 feet (60 m) a ground connection should be made at mid-span.
- Make sure the ground wire is routed towards the earth.
- Always keep the ground wire as straight as possible.
- Never attach the ground strap over the cable jacket.
- Never overtighten the ground strap. Overtightening will increase return loss.
- Never remove the coiling tool after tightening the ground strap. Removal of the tool will cause the strap to loosen, compromising the electrical contact.
- When applying butyl rubber tape, always start at the bottom of the ground area and wrap toward the top to eliminate points where water may build up.
- When wrapping over the butyl tape with electrical tape, start at the bottom and wrap toward the top, and then toward the bottom, finishing at the top using five layers of tape.
- Gently stretch the electrical tape during wrapping to eliminate wrinkles which can become channels where water could flow.
- Do not stretch the electrical tape during the last two turns of the fifth layer. Stretched tape will eventually come loose and create a "flag."
- Apply non-oxidizing grease (gray compound) between ground wire terminal and the point of attachment to prevent oxidation of these surfaces.
- The same rules that apply to tower installations also apply to rooftop installations. Make sure that the ground wire is directed away from the antenna.

Notes:

1

Loosely attach the ground wire terminal to the attachment point (bus bar, etc.). Then, position the ground strap on the cable or waveguide and make a knife cut on both sides of the ground strap. Remove the jacket between the two cuts, being careful not to score the outer conductor.

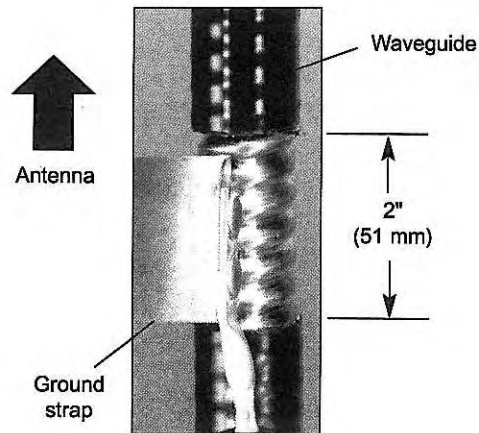

2

Cut off a piece of butyl rubber tape 3 inches (76 mm) long and wrap it around the ground wire near the ground strap.

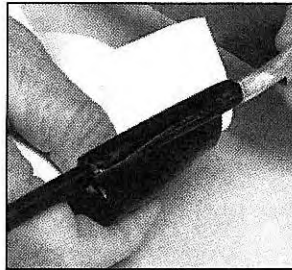

3

Check to make sure that the ground strap flange is on the H-plane of elliptical waveguide. Center the ground flange on the waveguide.

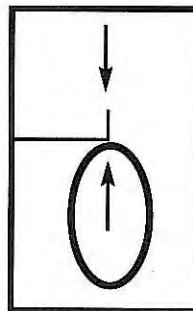

Notes:

4

Wrap the ground strap around the outer conductor and insert the tongue through the slot in the flange.

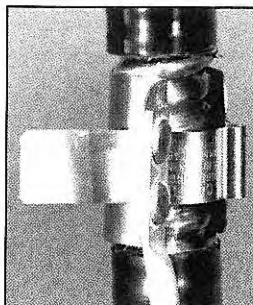

5

Insert the tongue of the ground strap into the coiling tool and rotate the tool in toward the cable with a screwdriver. Coil the strap tightly against the flange until the expansion section **begins to flatten**. (Do not remove the coiling tool.) *Do not rotate or otherwise move the ground strap or distort the flange after tightening.*

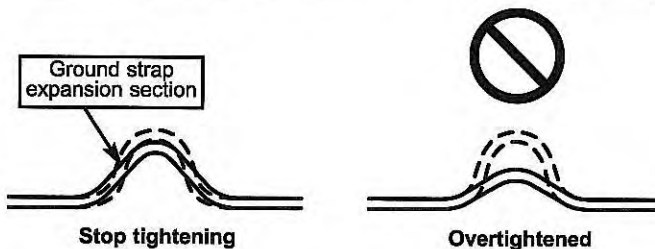
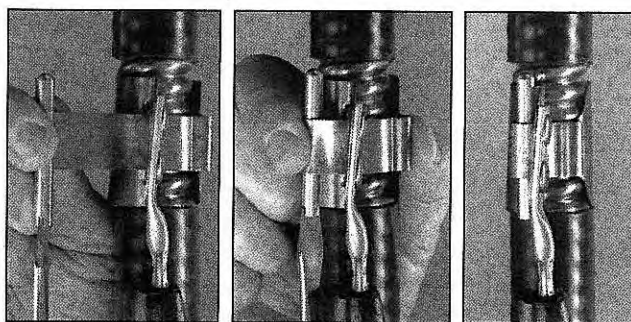

6

Press and form the butyl rubber tape on the ground wire to the jacket of the cable or waveguide. Then, cut off a piece of butyl rubber tape 3 inches (76 mm) long and fold it twice to make a small square. Press and form this tape onto the flange of the ground strap.



Notes:

7

Starting at the bottom, wrap the butyl rubber tape over the entire connection in a half-width, overlapping pattern, slightly stretching the tape as you wrap. *(Make sure that the tape completely covers the connection.)* Squeeze the tape along its edges to form it to the connection.

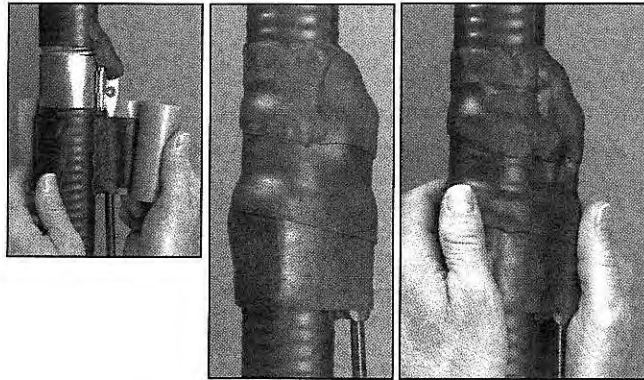

8

Wrap five layers of electrical tape over the entire connection so that each layer extends 1 inch (25 mm) beyond the ends of the previous layer. Start wrapping at the bottom, below the butyl rubber tape, and overlap the tape at half-width. *Gently stretch the tape enough to avoid forming wrinkles.* Reverse wrapping directions at the end of each layer. **DO NOT STRETCH THE TAPE FOR THE LAST TWO TURNS OF THE FIFTH LAYER** to avoid unraveling because of tension on the adhesive. Tightly squeeze the completed tape wrapping with both hands to ensure that the layers are secure.

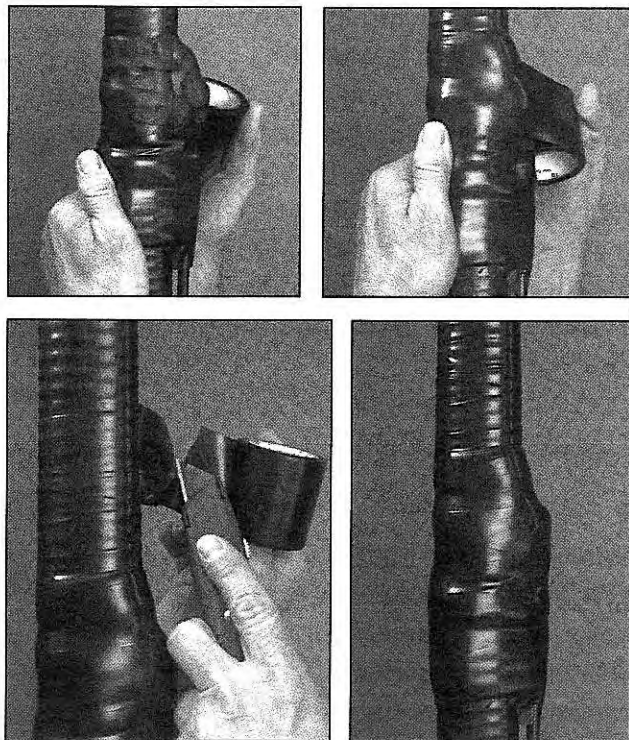

Notes:

Accessory 4 - Hoisting Grip for HELIAX® Coaxial Cable and Elliptical Waveguide

**READ ALL WARNINGS AND INSTRUCTIONS
BEFORE INSTALLATION**

⚠ WARNING

The following warnings alert you to possible dangers in misusing this product. Failure to obey a warning may result in injury or death to you or to others.

- **Do not use one hoisting grip for hoisting two or more cables or waveguides.** This can cause the hoisting grip to break or the cables or waveguides to fall.
- **Do not use the hoisting grip for lowering cable or waveguide.** Snagging of the cable or waveguide may loosen the grip and possibly cause the cable to waveguide to sway or fall.
- **Do not reuse hoisting grips.** Used grips may have lost elasticity, stretched, or become weakened. Reusing a grip can cause the cable or waveguide to slip, break, or fall.
- **Use hoisting grips at intervals of no more than 200 ft (60 m).**
- **Make sure that the proper hoisting grip is used for the cable or waveguide being installed.** Slippage or insufficient gripping strength will result if you are using the wrong hoisting grip.

Description

Hoisting grips are designed for hoisting cable or waveguide safely up a monopole or other tower so that mechanical connection to an antenna can be made. The grip is split and must be laced together on the cable or waveguide.

When the cable or waveguide is in position and fastened to the tower members, the hoist line can be removed. The hoisting grip may then be either attached to the monopole or other tower as additional support for the cable or waveguide or removed.

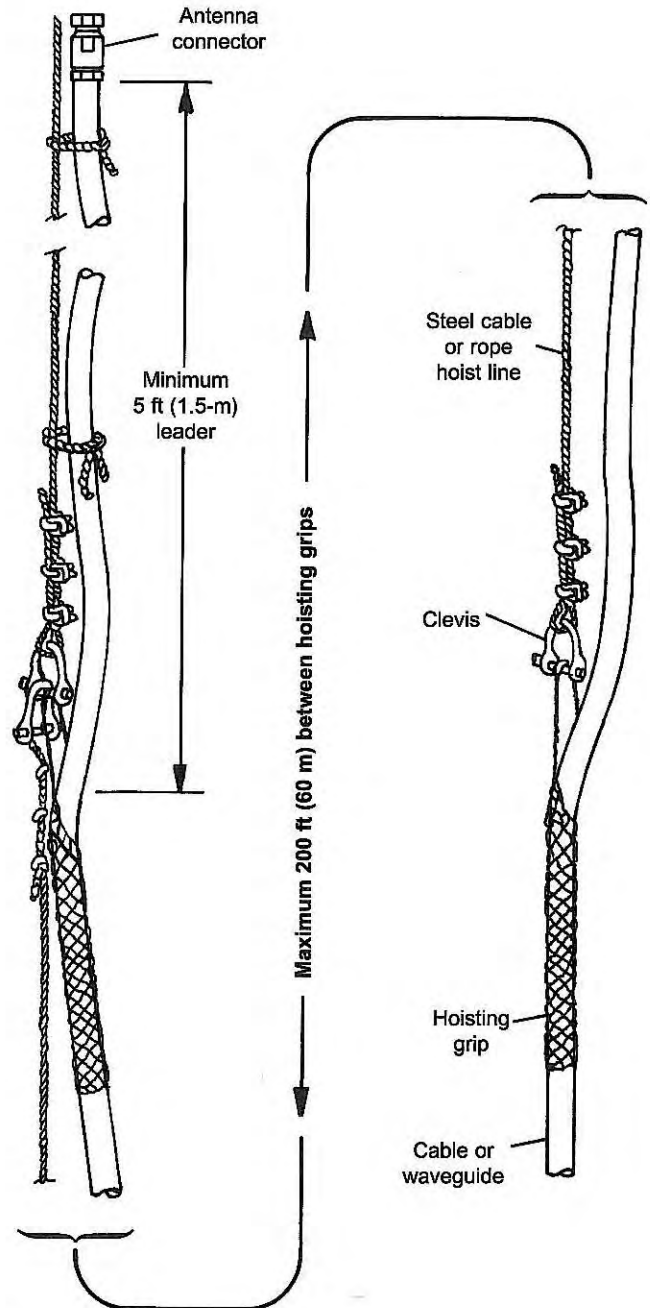

1

Place the hoisting grip at the proper location on the cable. Allow a sufficient length of cable or waveguide leader between the connector and the grip to reach the antenna input when hoisting is completed.

2

Identify the first three loop pairs to be laced at the crimp fittings. Make sure that the loops are not tangled. *It is important that the loop pairs are correctly matched to ensure maximum gripping strength.*

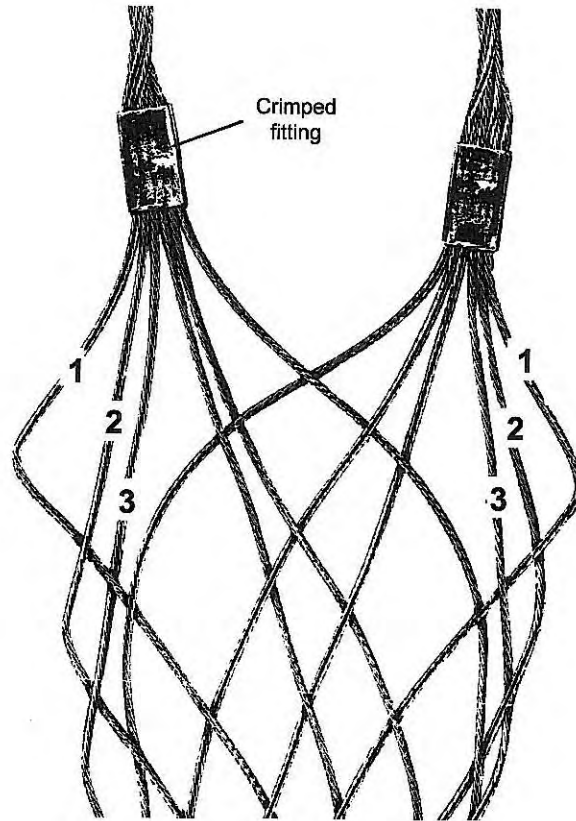

3

Tape both crimped fittings to the cable or waveguide. This will align the loop pairs of the hoisting grip and aid in lacing.

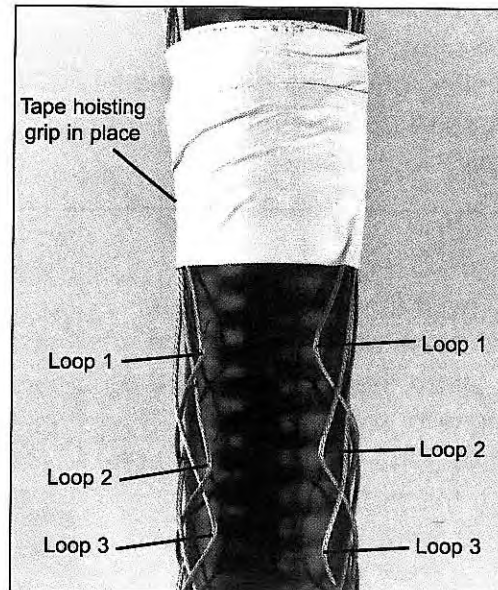

Notes:

4

Fold the lace in half to form a crease at the center. Starting at the top, pass the lace through the first loop pair so that the crease is between them.

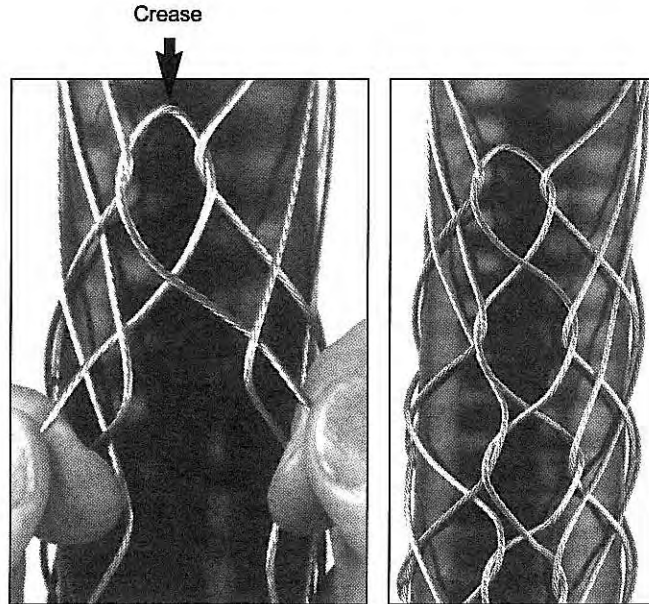

5

Continue lacing so that the seam is straight and the lace is pulled so that the space between both sides of the seam is no greater than the spaces of the mesh next to the loop. **Do not skip any loop pairs of the grip when lacing;** this will weaken the hoisting grip. *The grip can be compressed from bottom to top to simplify lacing.*

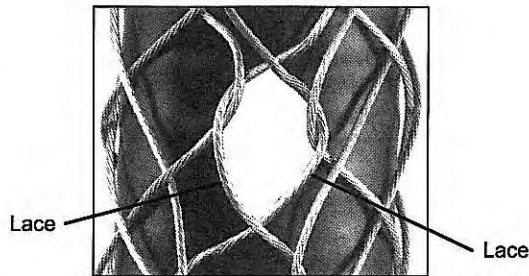

6

Tightly twist the lacing together several times at the end of the seam. Wrap the lace around the hoisting grip, twist it together, and thread the remainder of lace through the grip. **Do not tie knots or hitches with the lace because they will not hold.**

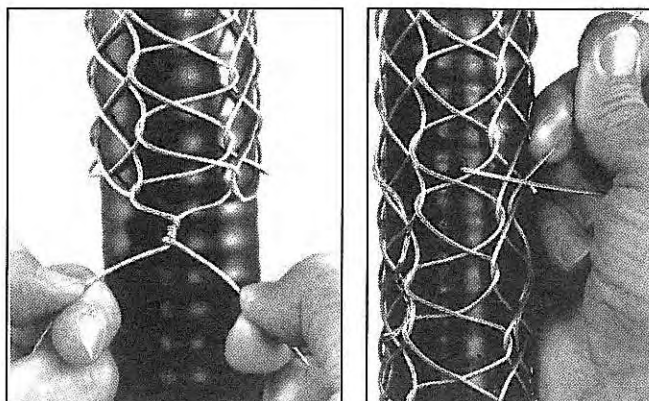

Notes:

7

IMPORTANT: First, remove the tape from the top of the hoisting grip. Then, place both hands firmly around the bottom of the grip and slide them upward to the top. This pulling action removes slack throughout the grip. Do this twice. *Taping the bottom 3" (76 mm) of the grip will help prevent slippage.*

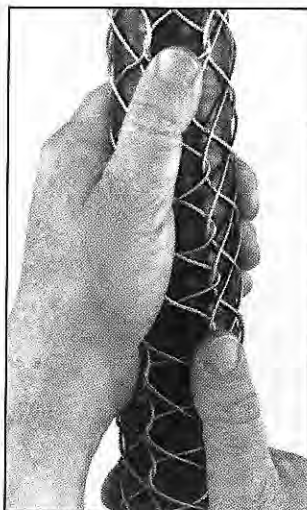

8

Attach the hoist line to the grip. Tie the cable or waveguide leader to the hoist line so that the leader does not dangle. Apply tension slowly to the hoist line to allow the hoisting grip to tighten uniformly on the cable or waveguide.

⚠ WARNING

Maintain tension on the hoisting grip during hoisting. Loss of tension can cause dangerous movement of the cable or waveguide and result in injury or death to you or others on or near the monopole or other tower. Also, do not release tension on the grip until after the cable or waveguide has been fastened to the tower members.

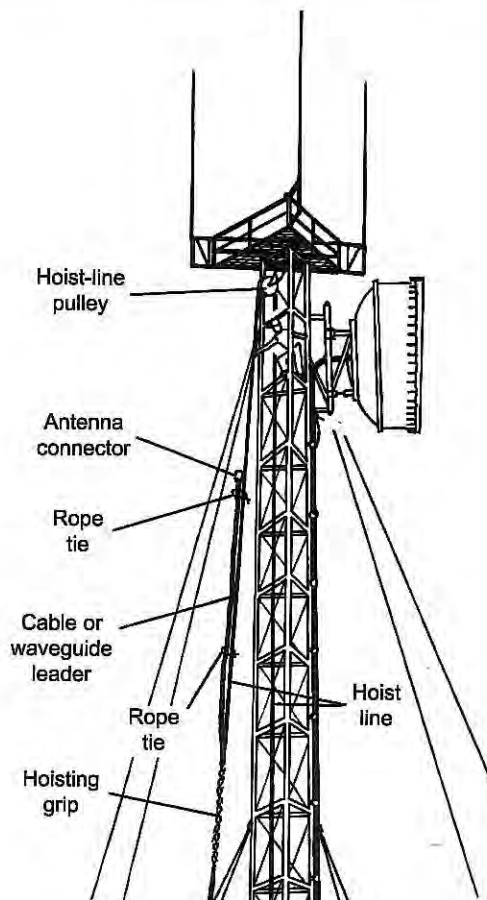

Notes:

Accessory 5 - Support/Hoisting Grip for HELIAX® Coaxial Cable

READ ALL WARNINGS AND INSTRUCTIONS BEFORE INSTALLATION

WARNING

The following warnings alert you to possible dangers in misusing this product. Failure to obey a warning may result in injury or death to you or to others.

- Do not use one hoisting grip for hoisting two or more cables. This can cause the hoisting grip to break or the cables to fall.
- Do not use the hoisting grip for lowering cable unless the clamp is securely in place.
- Do not reuse hoisting grips. Used grips may have lost elasticity, stretched, or become weakened. Reusing a grip can cause the cable or waveguide to slip, break, or fall.
- Use hoisting grips at intervals of no more than 200 ft (60 m).
- Make sure that the proper hoisting grip is used for the cable being installed. Slippage or insufficient gripping strength will result if you are using the wrong hoisting grip. Refer to the table below.

Hoisting grip	HELIAX® coaxial cable	Hoisting grip	HELIAX® coaxial cable
L45SGRIP	LDF4.5-50	FS1GRIP	FSJ1-50A
L5SGRIP	LDF5-50A	L1SGRIP	LDF1-50
L6SGRIP	LDF6-50	E2L2SGRIP	EFX2-50, LDF2-50
L7SGRIP	LDF7-50A	F2C2SGRIP	FSJ2-50, C2FP-50
L12SGRIP	LDF12-50	F4SGRIP	FSJ4-50B
		L4SGRIP	LDF4-50A

Description

Support/hoisting grips are designed for hoisting cable safely up a monopole or other tower and providing permanent support so that mechanical connection to an antenna can be made. A clamp is placed over the grip and secured to the cable with a special tool. When the cable is in position and the grip handle is fastened to a monopole or other tower member, the hoist line can be removed.

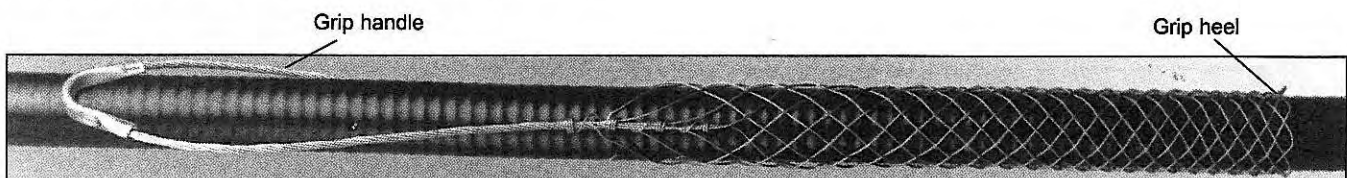
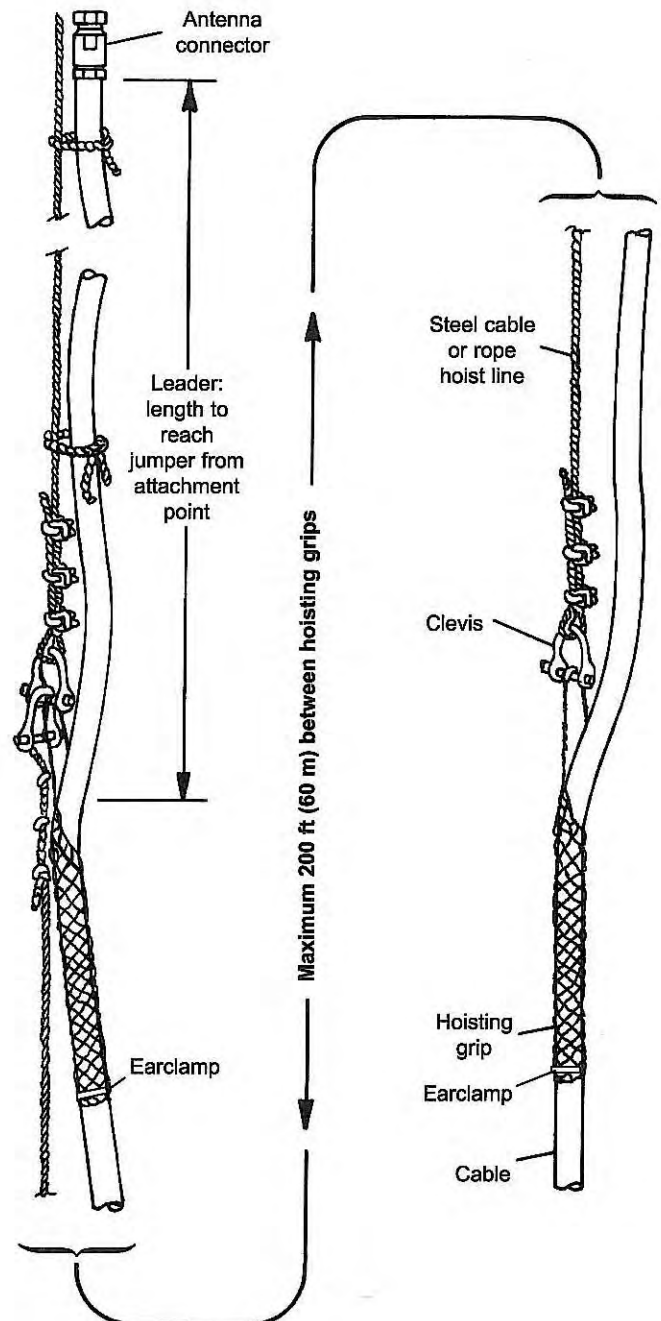

1

Compress the grip ends towards each other and slide the grip heel (woven end) onto the cable. Place the hoisting grip(s) at the proper location on the cable before attaching the connector. Allow a sufficient length of cable leader to reach the antenna input when cable hoisting and attachment of the grip handle is completed. Hold the heel with one hand and firmly slide the other hand along the grip to tighten it.

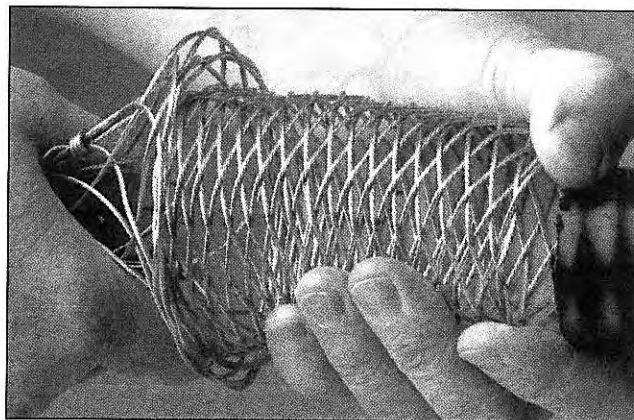

2

Open the earclamp and position it over the grip 1" (25 mm) from the heel. Snap the earclamp closed, ensuring that the 3 stops are fully seated in the 3 openings.

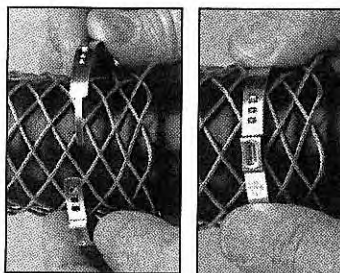

3

Crimp the earclamp with Andrew crimping tool (Andrew 243333) at each hoisting grip clamp location.

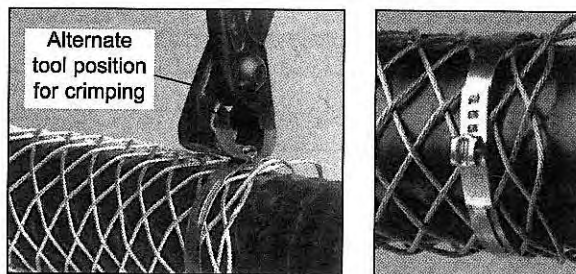
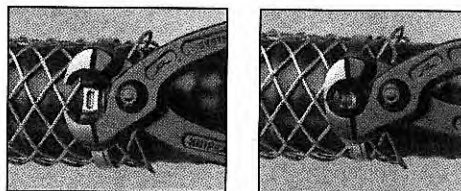

Notes:

4

Attach the hoist line to the grip as shown. Tie the cable leader to the hoist line so that the leader does not dangle. Apply tension slowly to the hoist line, allowing the hoist grip to tighten uniformly on the cable.

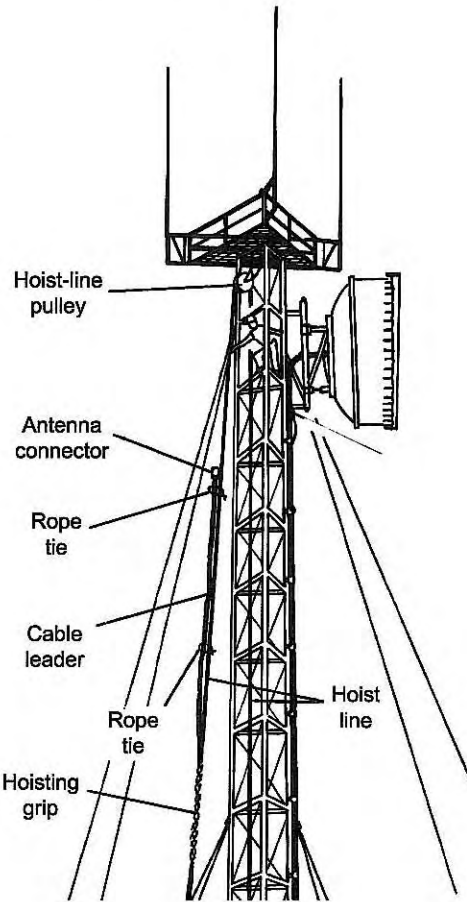

! WARNING
 Maintain tension on the hoisting grip during hoisting. Loss of tension can cause dangerous movement of the cable and result in injury or death to you or others on or near the monopole or other tower. Also, do not release tension on the grip until after the cable has been fastened to the monopole or other tower members.

Notes:



Appendixes

Appendix 1 Glossary

“A-Block” Carrier

A 30-MHz PCS provider serving a Major Trading Area in the frequency block 1850-1865 MHz paired with 1930-1945 MHz.

AC (Alternating Current)

The term usually associated in describing a 50- to 60-Hz electric power source. It is an electric current where the value is continually changing at some frequency and continually changing directions at a sinusoidal rate. The flow of ac in a circuit is affected by resistance and inductance.

AF (Audio Frequency)

The typical range for a telephone circuit is 300-3400 Hz.

AGC (Automatic Gain Control)

A circuit arrangement that adjusts receiver gain in response to changes in the input level.

American National Standards Institute (ANSI)

A non-profit, privately funded membership organization that coordinates the development of U.S. voluntary national standards.

Ampere

The unit of measurement for electric current flow.

Advanced Mobile Phone System (AMPS)

An analog cellular telephone standard, developed in the U.S., in which frequency modulation is used for the voice channel and binary shift keying is used for signaling. AMPS is the world's most widely deployed cellular standard.

Amplifier

A device used to amplify microwave signals.

Amplifier Bandwidth

The frequency range over which an amplifier provides the performance required. Bandwidth is defined as the highest frequency of operation minus the lowest frequency of operation divided by the center frequency of operation, and is thus expressed as a percentage.

Amplitude

Maximum of extreme value of a radio frequency, electric current, or waveform from an average value or some

predetermined or assigned value.

Amplitude Modulation (AM)

Modulation of the baseband signal onto the carrier by varying the amplitude of the carrier.

Analog

A continuous or unbroken signal or display.

Antenna

A device for radiating and/or receiving electronic waves.

Antenna Gain

The amount by which an antenna concentrates its radiation in a given direction relative to what would have been obtained if an isotropic radiator had been used. Gain is expressed in dB.

Antenna Pattern

A measure of the microwave power radiated from an antenna as a function of angular direction from the antenna axis.

Area

The receiving area of an antenna is related to the physical size of the antenna modified to take into account shielding of the feed horn and non-uniform illumination of the antenna.

Attenuation

A reduction in signal power due to losses in transmission medium. This loss in magnitude occurs as a signal travels the length of a coaxial cable or waveguide, or as it travels in free space. Attenuation is expressed in decibels (dB) or as dB per foot or meter,

Azimuth

Bearing. The compass direction given in degrees from 0 to 360. It is a horizontal direction expressed as the angular distance between a fixed location (position of the observer) and the direction to an object or desired direction.

Balun

Device which converts from a balanced to an unbalanced transmission line; can be designed for any frequency.

Band

A group of adjacent radio frequencies in the frequency spectrum.

Base Station

A radio transceiver that is located near the center of each cell in a cellular telephone network. The transceiver communicates with all of the active cellular telephones in the cell and provides them with a connection to the switched telephone network.

Baseband

The electrical signal to be transmitted. This information signal may represent audio, video, or digital data.

Bandwidth

The frequency range over which the modulation sideband exists.

Baud

A unit of signaling speed. The speed in bauds is the number of code elements per second.

Baud Rate

The rate at which a modem is changing the state of a line of data.

“B-Block” Carrier

A 30-MHz PCS carrier serving a Major Trading Area in the frequency block 1870-1885 MHz paired with 1950-1965 MHz.

Bel

A unit of measurement of gain equivalent to a 10 to 1 ratio of power gain. Equivalent to 10 decibels

Bit

An abbreviation of “binary digit”. A unit of computer information equivalent to the result of a choice of two alternatives: on or off, yes or no, or zero or one.

Bit Stream

A continuous series of bits transmitted over a communications link.

Broadcast

The process of sending a message from one station in a network to all other stations in the network.

C-Band

A band of radio frequencies, extending from 3.9 to 6.2

GHz, used for satellite and terrestrial microwave communications.

“C-Block” Carrier

A 30-MHz carrier serving as a Basic Trading Area in the frequency block 1895-1910 MHz paired with 1975-1990 MHz.

Calibration

The comparison of a device to some traceable standard so the rated accuracy can be verified.

Carrier

The radio frequency wave that is modulated by the baseband information signal.

Carrier-to-Noise Ratio

The ratio of the received microwave carrier to the microwave noise in the receiver.

Cavity

A microwave resonant circuit.

Cells

A group of radio transmitters and receivers designed to provide wireless coverage to a given area.

Cell Splitting

A means of increasing the capacity of a wireless system by subdividing or splitting cells into two or more smaller cells.

Cellular Telecommunications Industry Association (CTIA)

The Washington, D.C. based trade association representing the interests of the wireless telecommunications industry.

Cellular Radio

Mobile telephone system providing access to switched telephone networks in principal cities.

Channel

A path along which a communications signal is transmitted.

Characteristic Impedance

(Z_0); the ratio of the voltage to the current at every point along a transmission line on which there are no standing waves.

Choke Joint

A connection between two waveguides which provides effective electrical continuity without mechanical continuity at the inner walls of the waveguide.

Circularly Polarized Wave

An electromagnetic wave for which the electric and/or magnetic field vector at a point describes a circle.

Circulator

A 3-port component containing ferrite material which allows microwave signals to pass from one port to the second, but routes signals coming into the second port into a third, and routes signals coming into the third port back into the first port.

Clevis

A U-shaped metal shackle with holes in each end through which a pin is run. Used as a fastening device for hoisting components and equipment.

Coaxial Cable

Two-conductor cable with one conductor inside an outer, tubular conductor and concentric with it.

Co-location

The siting of two or more separate companies' wireless antennas on the same support structure.

Conductivity

A measure of the ability of a material to act as a path for electric flow. It is the reciprocal of resistivity and is expressed as mhos/meter.

Conical Scan Radar

A tracking radar which rotates its beam in a conical pattern to determine the angular location of the target. Several pulses are required to obtain the angular information.

Continuity

An uninterrupted electrical path.

Crosspol Discrimination

The difference in power level between vertical and horizontal polarization (XPD).

Crosstalk

Unwanted signals in a communications channel (telephone, radio, or computer) caused by the transfer of energy from another circuit or circuits.

"D-Block" Carrier

A 10-MHz PCS Carrier serving a Basic Trading Area in the frequency block 1865-1970 MHz paired with 1945-1950 MHz.

dBi

Decibels of gain in an antenna when it is referenced to an isotropic radiator.

dBm

A unit for expressing microwave power as a dB ratio above or below 1 milliwatt.

DC (Direct Current)

Term associated with a non-alternating current source from an acid or alkaline battery or from a rectified alternating current source. Since a direct current does not fluctuate in level, the only opposition to current is the dc resistance in the circuit.

Deceptive Jammer

A jammer which repeats the enemy radar signals back with time delay or frequency shift to provide false information to the enemy's radar.

Decibel

One tenth of a Bel. A unit used to express the relative increase or decrease in power. Decibels are used to express loss in transmission lines and used to indicate the gain or loss differences in circuits and antennas.

Declination

Angle between true north and magnetic north.

Dehydrator

A device that reduces or eliminates moisture from a microwave system. The dehydrator is typically coupled with a pressurization unit to maintain a moisture-free environment within waveguide.

Demodulation

The process of separating the baseband signal from a modulated carrier wave.

Desiccator

A substance, or a device that contains a substance, such as calcium oxide or silica gel, that has an affinity for water and is used as a drying agent.

Detector Diode

A device used to convert a microwave signal which travels slower in a dielectric material (insulator) than in a vacuum. The larger the dielectric constant, the slower the signal travels.

Dielectric

Nonconductive material such as foam used in coaxial cables. Air is the dielectric in waveguide and some coaxial cables.

Digital

Signals that can be represented by discrete or discontinuous units. Digital information is the language of computers. A form of digital signaling is Morse code.

Digital Modulation

A method for encoding information for transmission.

Dipole

A basic antenna consisting of a radiating element at right angles to the feed transmission line. Each radiating element is one quarter wavelength long, so that the total dipole is one half wavelength long.

Direct Broadcast Satellite (DBS)

A satellite communication system designed to broadcast television directly from the satellite to a home receiver.

Directional Antenna

An antenna having the property of radiating or receiving radio waves more effectively in some directions than others.

Directional Coupler

A component which samples the microwave signal traveling in one direction down a transmission line.

Directivity

Measured as the ratio of two power outputs from the auxiliary line when a given amount of power is alternately applied in the forward and reverse directions in the main line of the coupler.

Discontinuity

Any element in the system that can cause a loss of signal strength or a reflection back to the origin of the signal source lowering the value of return loss.

Diversity Antennas

Multiple antenna configurations, typically one above another, designed to minimize the effects of multipath fading.

Diversity Reception

A technique using multiple communication paths for the purpose of minimizing the effects of multipath fading. Different frequencies or different antenna spacings are used. When the received signal along one path is low, the signal on the other path or frequency is high. The higher signal at any given time is selected for uninterrupted communication service.

Domestic Satellite

A satellite communication system designed for communicating within a given continent or geographic area, such as the United States.

Drift

Movement of the frequency generator setting away from the previously set frequency.

Earth Station

Equipment which transmits to and/or receives signals from communications satellites. Includes receiver, transmitter (except in TVRO), antenna and positioner.

"E-Block" Carrier

A 10-MHz PCS carrier serving the Basic Trading Area in the frequency block 1885-1990 MHz paired with 1965-1970 MHz.

Effective Radiated Power (ERP)

The characteristic of a communication system transmitter equal to the product of the transmitter power and the transmitter antenna gain.

Efficiency

The ratio of the microwave power from an amplifier or oscillator to the total electrical power put into the amplifier or oscillator. Efficiency is expressed as a percentage.

Electric Field

The force field generated by electric charges. The electric field is the force on an electric charge exerted by all the neighboring charges.

Electromagnetic Field

The combined electric and magnetic field generated by electric charges. Electromagnetic fields travel in a wavelike fashion through space at the speed of light.

Elevation

The angular distance of an object above the horizon; the degree along the vertical plane to which an antenna is aimed above the horizon.

Encoding

The process of putting information into digital format.

ESM Receiver

The receiver used to detect and analyze microwave signals from enemy radars to decide the counter measure action to be taken.

Fade

Reduction in signal received by an antenna that is caused by reflection, absorption, refraction, or other physical or environmental factors.

Fade Margin

The amount of fade, expressed in decibels, that a microwave receiver can accept while still maintaining acceptable signal quality.

Fading

The variation and loss of radio field strength caused by changes in the Earth's atmospheric or tropospheric properties with time.

"F-Block" Carrier

A 10-MHz carrier serving a Basic Trading Area in the frequency block 1890-1995 MHz paired with 1970-1975 MHz.

Feed

Signal generator in an antenna that directs radiated signals into the parabolic reflector for transmission, or collects focused signals from the reflector for reception.

Ferrite Devices

Microwave components which contain ferrite materials. Ferrite materials are iron oxide insulators which affect microwave fields only at certain frequencies. Effects are determined by the magnetic properties of the ferrite material and by an applied external magnetic field.

Field Effect Transistor (FET)

A transistor formed on the surface of a semiconductor material consisting of source, drain and gate electrodes.

Filter

A component which allows a certain range of frequencies to be transmitted and reflects or absorbs all other frequencies.

Filter (Low Pass)

A filter that allows the lower frequencies to pass up to

the frequency specified (known as the cutoff frequency). A filter passes some frequencies and rejects other frequencies.

Free Space Attenuation (FSA)

The weakening of signal energy radiated from an antenna as it passes through the atmosphere on the way to the receiving antenna.

Frequency

The number of oscillations that an electrical signal completes in a time span of 1 second. Also the number of electromagnetic wavepeaks passing a given point in 1 second.

Frequency Domain Reflectometer

Fault location device used for VSWR testing using an RF frequency sweep.

Frequency Division Multiplexing (FDM)

A multiplexing technique where each signal to be multiplexed is shifted from its original frequency and then combined.

Frequency Modulation (FM)

Modulation of the baseband onto the carrier by varying the frequency of the carrier.

Frequency Pulling

The change of the microwave frequency of an oscillator from its desired value by changes in the supply voltage or changes in the characteristics of the microwave transmission line into which the power is delivered.

Fresnel Zones

Zones of either wave reinforcement or destructive interference caused by the interaction of direct radio waves and those waves reflected from the Earth's surface due to different phase relationships.

Front-to-Back Ratio

Ratio of the signal level at the main beam to the lobe of energy directed behind the antenna, expressed in dB. Ideally, this ratio should be as low as possible.

Full-duplex

Communications that take place in both directions at the same time.

GHz

Gigahertz. A unit of microwave frequency. 1 GHz equals 1 billion Hertz, or 1 billion (1,000,000,000) cycles per second.

Gain

The ratio of the output microwave power from an amplifier to the input microwave power to the amplifier. This ratio is expressed in dB.

Geosynchronous Orbit

The orbit of satellites around the earth's equator in which the satellite takes 24 hours to completely orbit the earth, so that the satellite appears in a stationary location relative to the rotating earth.

Gin Pole

An extension device, often made of aluminum, for tower rigging. It is usually mounted inside the antenna pipe to provide temporary elevation. The gin pole provides additional head room for the pulley at the top of the tower, and facilitates hoisting of the antenna.

GRANGER®

Registered trademark for tactical and strategic HF communications antennas. In December 1984, Andrew acquired the Antenna and Transmission Division of Granger Associates of Weybridge, England and Santa Clara, CA.

GRASIS®

Registered trademark under which towers, shelters and related products are sold. Andrew acquired tower and shelter manufacturer Grasis Corporation, Kansas City, Missouri, in July, 1983; these products are now built at the Andrew facility in Denton, Texas.

GRIDPAK®

Registered trademark for an Andrew low-windload grid reflector antenna. Manufactured at Lochgelly, Scotland, Melbourne, Australia and Sorocaba Brazil.

Ground Wave

A radio wave that is propagated over the Earth and is ordinarily affected by the presence of the ground and the troposphere. The ground wave includes all components of a radio wave over the Earth except the ionospheric and tropospheric waves.

GUIDELine®

Andrew registered trademark for large circular wave-

guide used in high power (60-360 kilowatt) UHF television applications requiring lowest possible attenuation.

Gunn Device

A microwave device using the unique electrical properties of gallium arsenide to generate or amplify microwave signals.

HDTV

High Definition Television (also called ATV - Advanced Television). Television technology, now being developed, which provides greatly improved picture quality with more than 1,000 "lines" of video information on the screen.

Half-duplex

Communication that can take place in either direction, but in only one direction at a time.

Halo

A grounding wire forming a loop on the inside or outside walls of an equipment shelter, usually about 2 feet from the ceiling. Conductors from the system components are connected to the halo, thus linking them to the main grounding unit for the tower.

Hanger

Connectors used to attach transmission line to a tower or other supports. Hangers are usually assembled on the ground and installed as transmission line is hoisted and connected to the antenna.

Harmonic

A sinusoidal component of a periodic wave having a frequency, which is an integral multiple of the fundamental frequency. For example, the second harmonic has twice the fundamental frequency.

Hatchet Knot

Any hopelessly tangled knot in a rigging line. (A hatchet is needed to undo it.)

Headache!

Vocal signal warning to crew members on the ground that something was dropped by the tower crew. Message: "Watch out - something's coming down - take cover!"

HELIAX®

Registered trademark for Andrew semi-flexible coaxial cable, elliptical waveguide, connectors and accessories.

Hz

Hertz. Basic unit of frequency measurement, equal to 1 cycle per second.

HF

High Frequency. Generally considered to be in the range of frequencies between 3-30 megahertz (MHz).

Hybrid Microwave

A microwave integrated circuit which is formed first by fabricating the micro strip circuitry and then adding to the circuitry separately fabricated microwave diodes and transistors.

Hypalon®

Durable elastomeric coated nylon fabric used on high-performance (HP) antennas.

Impatt Diode

A microwave device used to generate or amplify microwave signals. The impatt uses transit time effects, and so is the microwave semiconductor device capable of operating at the highest microwave frequencies.

HF

High Frequency. Generally considered to be in the range of frequencies between 3-30 megahertz (MHz).

Impedance

The opposition in an electrical or electronic circuit to the flow of alternating or radio signal current, which is related to circuit inductance, capacitance, and pure dc resistance, and measured in Ohms.

Incident Wave

The microwave signal which is traveling in the desired direction down a transmission line.

Inductance

The measure of the ability of a conductor to resist changes in current magnitude. The opposition to current is called inductive reactance, and is one of the three components of impedance.

Insertion Loss

The drop in power level, in dB, of a signal as it passes through a component, transmission line, or system. Insertion loss includes both the attenuation of the microwave signal and the reflection of the microwave signal as it enters the component.

Interface

The point of electrical connection of two or more parts which combine to form a circuit, and may be related to a mechanical connection such as the flange connection of an antenna to a coaxial cable flange.

Intermodulation Products

The additional signals generated by a microwave amplifier when the amplifier is amplifying two or more signals simultaneously.

International Satellite

A satellite communication system designed for communications from one continent to another.

Isolator

A component containing ferrite material which allows microwave signals to pass in one direction through the component, but absorbs microwave signals passing in the other direction.

Isotropic Antenna

A hypothetical point source antenna radiating or receiving equally well in all directions.

Ka-Band; Ku-Band

Sub-bands of K-Band microwave frequencies extending from 10.9 to 36 GHz; used largely for satellite communications. Ka-Band uses 17 to 20 GHz downlink and 29 to 30 GHz uplink; Ku-Band uses 11 to 12 GHz downlink and 14 GHz uplink.

kHz

Kilohertz, 1000 Hertz.

kW

Kilowatt. Unit of electrical power. 1 kW = 1000 Watts.

Line of Sight

A straight and unobstructed path between two communication sites, such as terrestrial microwave (TMW) antennas or Earth satellites. Microwave is a "line-of-sight" media.

LMR

Land mobile radio.

LNA, LNB, LNC

Low noise amplifier, low noise blocker, low noise converter. Used to amplify weak satellite signals at the earth station.

LPTV

Low-power TV. Local television broadcast outlets, serving viewers within 10-15 miles (16-24 km) of the transmitter location.

MACXLine®

Registered trademark for Andrew premium, coaxial rigid line used in high-power FM and TV broadcast applications. A patented bellows inner conductor section compensates for differential expansion between inner and outer conductors for high reliability and long life.

Magnetic Field

The force generated by electric current which is moving electric charges. The magnetic field is the force on a moving electric charge exerted by the other neighboring moving charges.

Main Beam

Center of a focused microwave signal that represents the strongest part of the signal. Locating and "locking on" to a clear main beam is the primary goal of antenna alignment.

Matched Transmission Line

A transmission line which is terminated in such a way that no power is reflected from the termination.

Mismatch, Impedance

When two components of unequal impedance are connected together, resulting in additional power loss (reduced return loss).

MHz

Megahertz. A unit of microwave frequency. 1 MHz equals 1 million Hertz or 1 million cycles per second.

Microwaves

Very short wavelength radio signals (wavelength 1 millimeter to 30 centimeters; frequency 300 MHz to 1 GHz) used for line-of-sight communications, as in terrestrial or Earth satellite systems; also in many radar systems.

Millimeter Frequency Range

A section of the microwave frequency range covering 30 GHz to 300 GHz.

Mode Spike

A sharp peak in a VSWR plot at a given frequency.

Modulation

Variation of the carrier amplitude, frequency, or both by the baseband signal, so that the baseband signal can be transmitted via the carrier.

Monopulse Radar

A tracking radar which determines the angular location of a target with a single pulse.

Moving Target Indicator (MTI) Radar

A radar which measures the range to the target and distinguishes between moving and stationary targets.

MTSO

Mobile telephone switching office.

Multipath Fading

The reduction in the amplitude of the received microwave signal due to a cancellation of the direct signal by signals reflected from other objects.

Multiplexer

A component which removes a desired band of frequencies from the signal in a transmission line and returns the other frequencies back into the transmission line.

NATE

Acronym for National Association of Tower Erectors.

Noise

Any extraneous electrical disturbance tending to interfere with the normal reception of a transmitting signal. Noise can be from natural sources, such as lightning; or from man-made sources, such as arc-welding equipment.

Noise Figure

Measurement of noise contribution of an amplifier relative to a noise-free amplifier at a reference temperature. Usually expressed in dB for Ku-band amplifiers.

Noise Power Density

Noise power density is another means of defining how much noise an amplifier adds to the signal being amplified, and is the actual noise in picowatts or dBm per MHz of bandwidth.

Noise of a Room Temperature Termination

The noise generated by a room temperature termination is equal to -114 dBm/MHz or 0.004 picowatts/MHz. The

noise generated by a passive termination is directly proportional to the temperature of the termination.

Noise Temperature

Noise measurement of a system, as the absolute temperature of a resistive source delivering equal noise power. Expressed in Kelvin for C-band amplifiers.

Null

A minimum value or zero signal that can occur when using test equipment.

Null Indicator

A meter designed to indicate the balance, such as no current or no voltage, in a circuit.

OEM

Original equipment manufacturer.

Ohm

Unit of measurement for the amount of impedance or resistance that opposes current flow in a circuit.

Omnidirectional Antenna

An antenna producing essentially constant field strength in azimuth and having a directive radiation pattern in elevation.

One dB Compression Point

Operating condition when the gain of the amplifier is reduced by 1 dB from its small signal value.

Optical Fiber

Very thin glass fiber, smaller than a human hair, capable of carrying information encoded digitally as pulses of light.

Oscillator

A device to generate electrical signals. An oscillator generates a signal at a particular frequency and this frequency may be varied mechanically or electronically.

Oscillator Noise

Undesired signals that occur at frequencies other than the desired oscillator frequency.

Oscilloscope

A test instrument that uses a cathode ray tube, which permits a signal display for observation.

Pad

A section of transmission line which adds a fixed amount of attenuation.

Paging

The use of an outbound channel over which specific tones are sent to turn on a specific receiver. Information is sent to the pager once the receiver has been alerted.

Parabolic Dish

Classic shape of terrestrial microwave and earth station antenna main reflectors. The function is to focus the signals hitting the surface to a single focal point (the feed or feed horn) or the subreflector.

Parametric Amplifier

A device used to amplify weak microwave signals using a varactor diode. The parametric amplifier has the lowest noise figure of any microwave device.

Path Clearance

Space free of obstruction (buildings, trees, other towers, etc.) between microwave antennas that permits uninterrupted line-of-sight transmission of radio signals.

Path Loss

Deterioration of signal between two antennas caused by various factors, including moisture, obstruction, signal interference, etc.

Period

The time it takes an electrical signal to complete one oscillation. Mathematically equal to the inverse of the frequency.

Personal Communications Systems (PCS)

FCC terminology for a group of intelligent, digital wireless, personal two-way communications systems in the 1.8 to 2.4 GHz range (U.S.).

Phase

A description of the time difference between two electrical signals of the same frequency. Phase is expressed in degrees, with 360 equal to 1 period time difference.

Phase Shifters

A component which controls the phase of a microwave signal.

Phased Array Radar

A radar which moves its beam through space by changing the phase of a multiplicity of transmitting elements which make up the antenna, rather than mechanically moving the entire antenna.

Picocell

A cellular base station with extremely low output power designed to cover an extremely small area, such as one floor in an office building.

Plane

A flat surface. A straight line connecting any two points that lies completely on or in the surface of a plane.

Planar

Lying on a two-dimensional plane; flat. Used to describe flat-surfaced shield radomes (planar radomes) as opposed to convex, or bubble-shaped, radomes.

Polarization

The direction of the electric field in the electromagnetic wave radiated from an antenna. Polarization may be horizontal, vertical or circular.

Post Tuning Drift

The change of the oscillator frequency from the original value after an oscillator has been changed from one frequency to another desired frequency.

Power

The rate at which electrical energy is generated or expended.

Power Density

This applies to electromagnetic waves traveling in space. Power density is equal to the power in a signal divided by the surface area over which the signal is spread.

Propagation Velocity

The speed that an electrical signal or an electromagnetic wave travels. This generally is equal to the speed of light. Note: the velocity of any wave is equal to its frequency times its wavelength.

Pulse Code Modulation (PCM)

The baseband signal is sampled in time and each sample is represented by a digital code.

Pulse Compression Radar

A radar which obtains high range resolution by varying the frequency of the transmitted microwave signal and then compresses the pulse in the receiver.

Pulse Doppler Radar

A radar which measures both the distance to a target and its velocity, by measuring both the change in frequency of the reflected signal and the time required for the microwave signal to travel from the transmitter to the target and back to the radar.

Radiation Pattern

A graphical presentation of the antenna's directivity as a function of azimuth rotation. The envelope of the pattern is a worst case representation for the number of patterns taken on the range and by superimposing right and left side measurements. The envelope is created by locating all the peaks and drawing a line connecting those points. The envelope defines rated performance of the antenna and the pattern is used by frequency coordinators.

RADIAX®

Registered trademark for Andrew slotted coaxial cable, designed to function as a continuous antenna. Used for communication systems inside buildings, mines, subways, tunnels and highly localized broadcasting such as highway advisory radio.

Range Gate Pulloff

A deceptive jamming technique where the radar signal is delayed before being retransmitted by the jammer to make the radar think that the target is at a different distance from the radar.

Range Measuring Radar

A radar which measures the distance between the radar and a target by determining the time required for a microwave signal to travel from the radar to the target and back.

Reactance

Capacitive or inductive. Either reactance causes a phase shift of 90 degrees between the voltage and current in opposition to each other. Measured in Ohms.

Reference Signal

The sampled output from a sweep oscillator used for comparison to a measured signal.

Reflected Wave

The microwave signal which is reflected from a component and propagates back towards the generator.

Reflection Coefficient

The numerical ratio of the reflected voltage to the incident voltage. Can also be expressed as a percentage by multiplying by 100.

Return Loss

A measure of reflected energy in dB resulting from imperfections in the antenna and transmission line system. Return Loss is directly related to VSWR.

Receiver Selectivity

That characteristic which determines to what extent the receiver is capable of differentiating between the desired radio signal and disturbances of other adjacent frequencies.

RF

Radio frequency. The portion of the electromagnetic spectrum reserved for radio transmission.

Rigging

The system of lines, pulleys, and related equipment used to hoist equipment, tools, and people up a tower. Also, the process of preparing and installing this equipment at a site.

Saturation Gain

The gain of an amplifier when the maximum saturation power is being obtained.

Saturation Power

The maximum power that can be obtained from an amplifier.

Scaler Network Analyzer

Fault location device used for VSWR testing. Convenient for field use.

Search Radar

A radar which scans its beam over a given volume of space to determine if targets are present.

Semiconductor

A material whose resistivity is between that of metals and insulators.

Sensitivity

The least signal input level capable of causing an output signal having the desired characteristics.

Shielding

Parabolic antenna shielding is a cylindrical, metallic protective screen generally attached to the reflector rim that improves radiation pattern performance by limiting signal interference from other antennas. RF absorbing material is sometimes placed at critical locations inside the shield to reduce side and back lobes of the radiation pattern.

Cable shielding is an electrical foil or braid wrapped around the conductor to reduce interference to or from the conductor.

SHF

Super high frequency, 3 GHz to 30 GHz.

SHX®

Registered Andrew trademark for a horn reflector antenna, a super high performance antenna.

Sidebands

The frequencies that are present in amplitude modulated or frequency modulated carrier waves due to the modulation process.

Side Lobes

Off-axis response of an antenna. Radiation from an antenna at angles other than the desired direction.

Signal-to-Noise Ratio (S/N)

The ratio of the received signal to noise power after the signal has been demodulated. A measure of how noise free the baseband signal is.

Single Sideband (SSB)

An amplitude modulated process where the carrier and one set of modulation sidebands are removed to reduce bandwidth requirements.

Sinusoid

Sine curve or sine wave. Sinusoidal: relating to or shaped like or varying according to a sine curve or sine wave.

Site Survey

For installers, the process of verifying that a tower site is properly prepared for antenna installation, including site clearance, tower construction, electrical work, etc.

Slot

The equivalent of a dipole, used in the high frequency end of the microwave band. The slot is approximately

one half wavelength long, and has a radiation pattern similar to that of a dipole.

Small Signal (Linear) Gain

The gain of an amplifier when it is operated with an output power much less than its maximum power capability.

Spectrum Analyzer

Fault location device that generates a source signal and measures it as it moves through the system to provide status information.

Speed Of Light

300 million meters per second. The speed of light is the velocity of electromagnetic waves.

Spike

An unwanted pulse of relatively short duration superimposed on a signal.

SPIRA-CONE®

Registered trademark for Andrew transportable omnidirectional HF antenna which uses a four-arm conical logarithmic spiral; used in medium to long range applications such as shore-to-ship and ground-to-air.

Spread Spectrum

A radio communications technique that "spreads" the transmitted signal across a wide band of frequencies by constantly shifting its frequency.

Surge Arrestor

A protective device for limiting surge voltages on equipment by discharging or bypassing surge current.

Synthetic Aperture Radar (SAR)

A radar using a single antenna element, and which obtains extremely high angular resolution by moving this single element over a long distance, storing the information obtained from the antenna at each position, and then recombining received information.

TDR

Time domain reflectometer. Device capable of sending signals through a network medium to check cable continuity and other attributes. TDRs are used to find physical layer network problems.

TEGLAR®

Registered Andrew trademark for polymer-coated fabric used for radomes, a flexible covering which protects microwave antennas against accumulation of ice, snow and dirt and reduces windloading.

Terrestrial Microwave Relay

A microwave communication system located on the surface of the earth. Often also called a line-of-sight, microwave communication system.

Time Division Multiplexing (TDM)

A multiplexing method where several signals are combined by forming PCM codes of each and then interweaving the PCM pulses.

Tracking Radar

A radar which directs its beam into a given area of space to determine accurately the angular location of a target.

Transceiver

A transmitter and receiver combined in the same mechanical housing or case and sharing many of the same circuits or modular components.

Transmission Line

A structure for conducting microwaves from one location to another.

Trapeze

Transmission line support made of aluminum angle or unistrut that extends below the ice bridge between the tower and the equipment shelter. Typically assembled separately before installation of the transmission line.

Torsion Box

A reinforcing plate that "boxes in" the reflector to strengthen it. Shielding can be attached to the antenna using the torsion box.

Troposphere

The part of the Earth's atmosphere in which temperature generally decreases with altitude, clouds form, and convection is active. It occupies the space above the Earth to a height of about 10 kilometers.

TX/RX

Transmit/receive.

UGX®

Registered trademark for Andrew ultra-gain antenna which offers higher gain than UHX and HP Series antennas of equivalent size.

UHF

Ultra high frequency. Generally considered to be in the range from 300 to 1000 MHz.

UHX®, UHXII®

Registered trademarks for Andrew ultra-high-performance microwave antennas; ideal for use in areas of heavy congestion. UHXII includes a TEGLAR® radome.

UMX®

Registered trademark for Andrew multiband microwave antenna. Provides simultaneous dual-frequency band, dual-polarized operation in the 4/6 GHz, 4/6.5 GHz or 6/11 GHz bands.

Upconverter

A device using varactor diodes to add a low frequency signal to a microwave signal and thereby increase the frequency of the microwave signal.

Uplink

Microwave radio link in which an earth station transmits a signal up to a communications satellite.

Varactor Diode

A PN-junction operated with reverse bias in the nonconducting region. In this region, the diode has a variable capacitance which is dependent upon the applied voltage. The varactor is used for electronic tuning and in various other microwave applications.

Varactor Multiplier

A device which multiplies a microwave signal to a harmonic frequency to obtain high frequency microwave signals from a lower frequency source.

Variable Attenuator

A component which reduces the level of the microwave signal passing through it by an adjustable and controlled amount.

Velocity Gate Pulloff

A deceptive jamming technique where the frequency of the radar signal is shifted by the jammer so that the radar thinks that the target is moving at a different velocity.

Velocity Measuring Radar

A radar which measures the velocity of a target by determining the change in the frequency of the reflected microwave signal due to the targets velocity. This change in frequency is called the doppler shift, and so this type of radar is often called a doppler radar.

Vertex Plate

A flat, circular plate installed at the center of the antenna reflector that puts the signal in the immediate

area of the antenna feed out of phase to reduce antenna VSWR.

VHF

Very high frequency, usually in the range of 30 to 300 MHz.

Volt

A unit of electrical potential difference across a resistance of one ohm when one ampere of current is running through it.

VSWR (Voltage Standing Wave Ratio)

The numerical ratio of the maximum voltage to the minimum voltage that would exist on the uniform reference transmission line. If the reflection coefficient (RC) is known, $VSWR = (1 + RC) / (1 - RC)$. For example, if $RC = 0.2$, $VSWR = 1.2 / 0.8 = 1.5$

Watt

Basic unit of power measurement. Named for James Watt, inventor of the steam engine which provided locally generated power and transformed the industrial technology base of the world.

Wave

A disturbance in a medium which is a function of time or space or both. Energy may be transmitted by waves; for example, audio and radio waves.

Waveguide

A transmission line consisting of a hollow metallic pipe. The microwaves are conducted inside the pipe. The cross-sectional shape of the pipe may be rectangular, circular, or elliptical.

Wavelength

The distance that an electrical signal (or an electromagnetic wavepeak) travels in a time span equal to one period.

Wireless

Describes radio-based systems that allow transmission of telephone or data signals or both through the air without a physical connection, such as a coaxial cable or fiber-optic cable.

Appendix 2

Connector Replacement Parts

Connector PIN-PAKS. Replacement connector center pins individually packaged in sets with quantities as given below. Contact Andrew for other replacement pins.

Each pin can be easily separated from the set. PIN-PAKS for 7/8" cable and smaller include five replacement pins; PIN-PAKS for 1-1/4" and 1-5/8" cable include two replacement pins.

Connector type	PIN-PAK type No.	Quantity per kit
C41SW	241051-3	5
F1PNM-H	242881	5
F2NM, F2NM-H	242075-3	5
F2PDM	114402-2	5
F2PNM, F2PNM-H	252075-4	5
F4NF	241496-3	5
F4NM, F4NM-H	241455-3	5
F4NMV2	243640-2	5
F4PDM	114417-2	5
F4PDMV2	243465-2	5
F4PNF	241496-4	5
F4PNM, F4PNM-H	241455-4	5
F4PNMV2	243472-2	5
L2NM, L2NM-H	48335-3	5
L2PNM, L2PNM-H	48335-4	5
L4NF	242855	5
L4NM, L4NM-H	241730-3	5
L4PDM	222483-2	5
L4PNF	242855-2	5
L4PNM, L4PNM-H	241730-4	5
L5NF	43157-2	5
L5NM	43158-5	5
L5PDF, L5PDF-BH	114105-2	5
L5PDM	114105	5
L5PNF	241092	5
L5PNM, L5PNM-H	241495	5
L6PDF, L6PDF-BH	114105-4	2
L6PDM	114105-3	2
L6PNF	241057	2
L6PNM, L6PNM-H	243370	5
L7PDM	242960	1
L7PNF	241056	2
L7PNM	243371	2
V5PNF	244985-2	5
V5PNM	244983-2	5
V5PDF	244989-2	5
V5PDM	244987-3	5

Connector Reattachment Kits. The kit includes rubber O-ring and gasket parts to replace those which may be damaged during disassembly and subsequent reattachment of connectors. O-rings or gaskets for interfacing connectors are not included.

Cable type	Connector type(s)	Kit type number
Foam-dielectric cables		
LDF2-50	L2 and L42 Series	34767A-38
LDF4-50A	L44 Series, except L4NM, L44PCW, L44PCN, L4NM, L44PCW, L44PCN	34767A-27
FSJ4-50B	F4 and 44S Series	34767A-51
LDF5-50A	L5 and L45 Series	34767A-39
LDF6-50	L6 and L46 Series	34767A-28
LDF7-50A	L7 and L47 Series	34767A-43
LDF7-50A	L7 and L47 Series	34767A-35
RingFlare™ Series		
LDF4-50A	L4PDM-RC, L4PDF-RC	L4RC-RKIT
LDF5-50A	L5PDM-RC, L5PDF-RC	L5RC-RKIT
LDF6-50A	L6PDM-RC, L6PDF-RC	L6RC-RKIT
LDF7-50A	L7PDM-RC, L7PDF-RC	L7RC-RKIT

Appendix 3

Inner Connector Soldering Techniques

You will need:

- Variable resistance soldering iron
- Rosin core flux solder coil:
63% tin, 37% lead, flux weight 2.4%;
0.062" solder for larger diameter inner connectors;
0.031" solder for smaller diameter inner connectors
- Brass pin pliers
- Leather strip
- Wire snips
- Knife

Prepare to solder:

- 1** Clean the surface of the inner conductor to make sure it is free of contaminants. Use a knife to remove oxides, dirt, and foam dielectric. Be careful not to remove any base metal from the inner conductor.
- 2** To start, set the soldering iron power to 4.1 on the ac scale. Adjust it higher or lower as required.
- 3** Solder should melt within eight seconds after the soldering iron tips touch the inner connector pin. The power setting is too high if the pin becomes discolored or if the electrode tips glow red. Electrode tips will also glow red if they are contaminated or if the electrodes are too short. Trim the electrodes or replace them to correct this condition.

Procedure for hollow inner connectors with no solder cup at base:

- 1** Place the spacing gauge (if provided) on the inner conductor and against the outer conductor. Place the inner connector pin on the inner conductor until it butts against the spacing gauge. If the pin has two solder holes, position them at the sides; if the pin has one solder hole, position the hole at the top.
- 2** Lightly press the end of the solder coil through the solder hole and against the inner conductor. Place the soldering iron tips against the underside of the pin.

3 When the solder melts, within two to five seconds, add a small amount of solder into each hole and remove the soldering iron. Hold the pin with pin pliers and reheat the joint. When the solder melts, rotate the pin 90° and add solder to each hole to fill it.

4 Remove the soldering iron and keep the solder joint motionless until the solder solidifies. Remove excess solder with wire snips or a knife, but do not remove the plating from the pin. Remove flux residue with a leather strip.

Procedure for inner connectors with solder cup at base:

- 1** Place the spacing gauge (if provided) on the inner conductor and against outer conductor. Insert a small piece of solder into the solder cup of the inner connector. The amount of solder will vary with the size of the solder cup.
- 2** Hold the pin vertical and place the soldering iron tips against the side of the pin cup and melt the solder.
- 3** Place the pin fully onto the inner conductor. If the pin has two solder holes, position them at the sides; if the pin has one solder hole, position the hole at the top.
- 4** Place the soldering iron tips against the underside of the solder cup.
- 5** When the solder melts, within two to five seconds, push and rotate the pin until it firmly butts against the spacing gauge. Add more solder through the solder holes if inner conductor is still visible.
- 6** Remove the soldering iron and keep the solder joint motionless until the solder solidifies. Remove excess solder with wire snips or a knife, but do not remove plating from the pin. Remove flux residue with a leather strip.

Inspect the solder joint. Refit or resolder if you find any of these problems:

- Pins not aligned with inner conductor. Pins must be parallel with the inner conductor.
- Burned or melted foam dielectric caused by excessive heat settings or excessive soldering. This will affect cable performance.
- Solder has a dull finish. The solder should be shiny to provide a good electrical path. Solder should fill the solder holes and form a bead around the end of the pin cup.

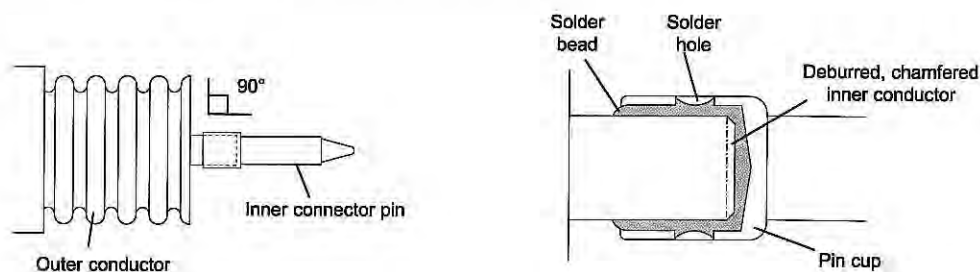

Appendix 4

Connector Attachment Checklist

<i>Look for Problem/Condition</i>	<i>Solution</i>
<input type="checkbox"/> Check back of clamping nut to make sure that the gasket is not protruding.	Remove clamping nut and reposition gasket.
<input type="checkbox"/> Check the foam for copper particles.	Clean with a hard bristle nylon brush.
<input type="checkbox"/> Check for excess solder on pin cup.	Remove solder with a knife or wire cutters.
<input type="checkbox"/> Check pin for straightness.	Reheat pin and align it 90° to outer conductor.
<input type="checkbox"/> Check for burnt or melted foam dielectric.	Remove 1/16" (1.5 mm) of foam with a sharp knife or rework cable end.
<input type="checkbox"/> Turn outer body only when making connection with clamping nut.	Use appropriate size wrenches to prevent distortion of outer surfaces of connector.
<input type="checkbox"/> Be sure that connectors are tightened to correct specifications.	Use torque wrenches if available. Be careful not to over tighten.
<input type="checkbox"/> Check pin depth and straightness.	Use Andrew-specified tools for these steps.
<input type="checkbox"/> Check the interface for dirt or any foreign particles.	Clean with a cotton swab.
<input type="checkbox"/> Align connectors carefully to avoid cross threading.	Make all cable bends before connecting interfaces.

Appendix 5 Cable and Waveguide Bending Radii

Cable type	Minimum bend radii		Waveguide size	Minimum bend radius with rebending - in (mm)		Maximum twist deg/ft (deg/m)
	Inches	Millimeters		E-plane	H-plane	
FSJ1	1	25				
EFX2	1-3/4	45	EW17	28 (710)	81 (2060)	0.25 (0.75)
FSJ2	1	25	EW20	26 (660)	71 (1800)	0.25 (0.75)
FSJ4	1-1/4	32	EW28	22 (560)	52 (1320)	0.25 (0.75)
LDF1	3	76	EW34	17 (432)	47 (1194)	0.5 (1.5)
LDF2	3-3/4	95	EW37	17 (430)	41 (1040)	0.5 (1.5)
LDF4	5	125	EW43	15 (381)	35 (889)	0.5 (1.5)
LDF4.5	8	200	EW52	12 (305)	32 (810)	1 (3)
VXL5	5	125	EW63	10 (260)	29 (740)	1 (3)
AVA5	10	250	EW64	10 (260)	27 (685)	1 (3)
LDF5	10	250	EW77	9 (230)	25 (635)	1 (3)
LDF6	15	380	EW85	8 (200)	19 (480)	1 (3)
VXL6	10	250	EW90	7 (180)	19 (480)	2 (6)
LDF7	20	510	EW127A	6 (150)	15 (380)	2 (6)
VXL7	15	375	EW132	5 (130)	14 (360)	2 (6)
AVA7	15	375	EW180	6 (150)	11 (280)	2 (6)
LDF12	22	560	EW220	4 (120)	9 (230)	2 (6)
HJ4	5	125	EW240	4 (120)	9 (230)	2 (6)
HJ4.5	7	180				
HJ5	10	125				
HJ7	20	510				
HJ8	30	760				
HJ12	22	560				
HJ11	40	1015				
HJ9	50	1270				

Appendix 6 Coupling Torque Data for all N and 7-16 DIN Type Connectors

Connector coupling torque and wrench size

This is the torque required to mate one connector assembly securely to another (male to female) for proper pin engagement and O-ring compression to achieve optimum electrical and mechanical performance. This torque value is given in the connector bulletins and the Andrew catalog. Coupling nuts are universal throughout the Andrew connector line for a given connector type so that a common wrench size can be used as shown below.

Connector type	Coupling torque	Wrench size
N	15-20 lbf•in (1.7-2.3 N•m)	13/16"
7-16 DIN	18-22 lbf•ft (25-30 N•m)	1-1/4"

Appendix 7 Tool Reference

EASIAx Plus® Automated Cable Tools

Cable Type	Connector Type	Tool	Blade
LDF7-50A, AVA7-50	Standard, RingFlare™, OnePiece™, Positive Stop™	CPT-158U	CPT-BK7
LDF6-50	Standard, RingFlare, OnePiece	CPTL6	CPT-BK6
EFX2-50	Standard Type N	CPTL-E2L2N	CPT-BKS1
EFX2-50	Standard 7-16 DIN	CPTL-E2L2DIN	CPT-BKS1
LDF2-50	Standard Type N	CPT-E2L2N	CPT-BKS1
LDF2-50	Standard 7-16 DIN	CPTL-E2L2DIN	CPT-BKS1
FSJ4-50B	FSJ4 version 2	CPT-F4	CPT-BK
LDF4-50	RingFlare, Positive Stop	CPT-L4ARC1	CPT-BKS1
LDF4.5-50	RingFlare	CPTL45RC	CPT-BKS1
LDF5-50A	Standard, RingFlare, OnePiece, Positive Stop	CPT-78U	CPT-BK5
AVA5-50	RingFlare, Positive Stop	CPT-78U	CPT-BK5
AVA5-50	OnePiece	CPT-78U	CPT-BK5



EASIAx® Cable Preparation Tools

Cable Type	Connector Type	Tool	Blade
FSJ4-50B	FSJ4 version 2	MCPT-1412	209874
FSJ1-50B	FSJ1 version 2	MCPT-1412	209874
FSJ2-50B	Standard	MCPT-3812	209874
LDF4-50	Standard, RingFlare	MCPT-L4	MCPT-BK4
AVA5-50	RingFlare	MCPT-78	MCPT-BK5
AVA5-50	Positive Stop	ASMCPT-78	ASMCPT-BK5
LDF5-50A	Standard, RingFlare, OnePiece	MCPT-78	MCPT-BK5
VXL5-50	Standard, RingFlare, OnePiece	MCPT-78	MCPT-BK5



CPTV2 Series Manual Preparation Tools

Cable Type	Connector Type	Tool	Blade
LDF6-50	Standard, RingFlare, OnePiece	CPTV2-114	CPTV2-BK
VXL6-50	RingFlare, OnePiece	CPTV2-114	CPTV2-BK
LDF7-50	Standard, RingFlare, OnePiece	CPTV2-158	CPTV2-BK
VXL7-50	RingFlare, OnePiece	CPTV2-158	CPTV2-BK
AVA7-50	OnePiece, Positive Stop	CPTV2-158	CPTV2-BK



Andrew Torque Wrenches

Tool	Wrench Size	Description	Application
244373	2-5/8"	non-adjustable torque wrench	LDF12 connectors
244374	2-1/4"	non-adjustable torque wrench	LDF7 connectors
244375	1-7/8"	non-adjustable torque wrench	LDF6 connectors
244376	27 mm	non-adjustable torque wrench	LDF4.5 connectors
244377	1-1/4"	non-adjustable torque wrench	Coupling torque, DIN connectors
244378	1-1/4"	non-adjustable torque wrench	LDF5 connectors
244379	13/16"	non-adjustable torque wrench	Coupling torque, N connectors
245154	3/4"	non-adjustable torque wrench	LDF4 RingFlare™ connectors
247698	1-3/4"	non-adjustable torque wrench	LDF6 OnePiece™ connectors



Ground Kit Preparation Tools

Cable Type	Grounding Kit Type	Tool	Blade
FSJ4-50B	Standard	GKT-F4A	GKT-BKF4
LDF4-50	Standard, SGL, CSGL Series	GKT-L4A	GKT-BK512
LDF5-50A	Standard, SGL, CSGL Series	GKT-78A	GKT-BK512
VXL5-50	Standard, SGL, CSGL Series	GKT-78A	GKT-BK512
AVA5-50	Standard, SGL, CSGL Series	GKT-78A	GKT-BK512
LDF6-50	Standard, SGL, CSGL Series	GKT-114A	GKT-BK67
VXL6-50	Standard, SGL, CSGL Series	GKT-114A	GKT-BK67
LDF7-50	Standard, SGL, CSGL Series	GKT-158A	GKT-BK67
VXL7-50	Standard, SGL, CSGL Series	GKT-158A	GKT-BK67
AVA7-50	Standard, SGL, CSGL Series	GKT-158A	GKT-BK67



SnapStak Hanger Tool

Tool	Description
SHT-4	SnapStak Hanger Tool, quantity 1



Appendixes

Tool	Description
Tool Kits	
TB-COMP-KIT	Complete tool box, includes Individual Tools listed below plus MCPT-78, MCPT-L4, and MCPT-1412
244372	Wrench kit, includes three wrenches (1-1/4", 1-7/8" and 2-1/4") and carry bag

Individual Tools

114468	Pin depth gauge DIN-male
114469	Pin depth gauge DIN-female
224352	Safety knife
224354	Ruler
224355	Grease brush
224356	Point file
224360	Pin alignment tool
224363	Cable flare tool LDF4
224368	Cable flare tool LDF5
224373	Cable flare tool LDF6
224380	Pin depth gauge N-male
224390	Leather buffing strap
224391	Emery cloth
224392	Flare hammer
224393	Flat hammer
224394	Beveled hammer tip
224395	Pin depth gauge N-female

Tools by Cable Size

1/4"	MCPT-1412 209874 224361 224362 244394	EASIAx® Cable Preparation Tool for 1/4"-1/2" FSJ1-50 cable Replacement Blade Kit for MCPT-1412 tool Cut-off tool 7/32 Cut-off tool 8/32 Cut-off tool 9/32
3/8"	CPT-E2L2N CPT-E2L2DIN MCPT-3812 209874 224361 224362 244394	Automated/manual cable preparation tool for EFX2 and LDF2 cable, N type connectors only Automated/manual cable preparation tool for EFX2 and LDF2 cable, DIN type connectors only EASIAx Cable Preparation Tool for 3/8" FSJ2-50 cable Replacement Blade Kit for MCPT-3812 tool Cut-off tool 7/32 Cut-off tool 8/32 Cut-off tool 9/32
1/2"	CPT-BK CPT-BKS1 CPT-F4 CPT-L4ARC1 GKT-BKF4 GKT-BKS12	Replacement Blade Kit for CPT-F4 tool for FSJ4 cable Replacement Blade Kit for CPT-L4ARC1 tool for LDF4 cable Automated/manual cable preparation tool for 1/2" coaxial super flexible cable Automated/manual cable preparation tool for 1/2" coaxial cable Replacement Blade Kit for Ground Kit Preparation Tool for FSJ4 cable Replacement Blade Kit for Ground Kit Preparation Tool for LDF4 cable

Tool Description
Tools by Cable Size (cont.)

1/2"	GKT-BKU GKT-F4A GKT-L4A MCPT-L4 MCPT-BK4 MCPT-1412 209874 247696 241953 224361 224362 244394	Replacement Blade Kit for plastic grounding kit stripping tool for LDF4 cable Aluminum grounding kit stripping tool for FSJ4 cable Aluminum grounding kit stripping tool for LDF4 cable EASIAx Cable Preparation Tool for 1/2" LDF4-50A cable Replacement Blade Kit for MCPT-L4 tool EASIAx Cable Preparation Tool for 1/2" super flexible FSJ4-50B cable Replacement Blade Kit for MCPT-1412 tool 21 mm torque wrench for L4 OnePiece™ connectors Chamfer tool Cut-off tool 7/32 Cut-off tool 8/32 Cut-off tool 9/32
7/8"	CPT-BK5 CPT-78U FST-78 FST-78A GKT-78A GKT-BKS12 MCPT-78 244378 244459-5 245517	Replacement Blade Kit for CPT-78U 7/8" tool EASIAx Plus® Automated Preparation Tool for 7/8" cable Foam Separating Tool for LDF5-50B and VXL5-50 Foam Separating Tool for AVA5 Aluminum grounding kit stripping tool for 7/8" cable Replacement Blade Kit for aluminum grounding kit stripping tool for 7/8" cable EASIAx Cable Preparation Tool for 7/8" LDF, VXL, and AVA coaxial cable 1-1/4" torque wrench 1-1/4" open end wrench 1-3/8" open end wrench for OnePiece 7/8" connectors
1-1/4"	CPT-BK6 CPTL6 CPTV2-BK CPTV2-114 FST-114 GKT-BK67 GKT-114A 244375 244459-6 247698	Replacement Blade Kit for CPTL6 tool for 1-1/4" cable EASIAx Plus Automated Preparation Tool for 1-1/4" LDF6 coaxial cable only Replacement Blade Kit for CPTV2-114 and CPTV2-158 tool Manual cable preparation tool for 1-1/4" coaxial cable Foam Separation Tool for LDF6-50 and VXL6-50 Replacement Blade Kit for plastic grounding kit stripping tool for 1-1/4" cable Aluminum grounding kit stripping tool for 1-1/4" cable 1-7/8" torque wrench 1-1/4" standard or RingFlare™ connectors 1-7/8" open end wrench for 1-1/4" connectors 1-3/4" torque wrench for 1-1/4" OnePiece connectors
1-5/8"	CPT-BK7 CPT-158U CPTV2-BK CPTV2-158 FST-158 FST-158A GKT-BK67 GKT-158A 244374 244459-7	Replacement Blade Kit for CPTL7 tool EASIAx Plus Automated Preparation Tool for 1-5/8" cable Replacement Blade Kit for CPTV2-114 and CPTV2-158 tool Manual cable preparation tool for 1-5/8" LDF, AVA, and VXL7 cable Foam Separation Tool for LDF7-50 and VXL7-50 Foam Separation Tool for AVA7 Replacement Blade Kit for plastic grounding kit stripping tool for 1-5/8" cable Aluminum grounding kit stripping tool for 1-5/8" cable 2-1/4" torque wrench for 1-5/8" connectors 2-1/4" open end wrench for 1-5/8" connectors

Appendix 8

Lightning Protection of Transmission Lines

Good grounding protects RF equipment from lightning

Approximately 1,800 thunderstorms occur every moment on earth; that's about 16,000,000 a year. During storms, lightning travels at nearly half the speed of light and can strike ground 100 times a second (8,640,000 times a day). It hits several hundred humans, killing about one hundred, causes millions of dollars in property damage, and sparks hundreds of forest and brush fires each year in the United States alone. Contrary to popular belief, lightning will strike in the same place twice and can do so frequently. Though operators can't do anything about thunderstorms, there are preventive measures that can be taken to protect a site from damage inflicted by lightning.

The Likelihood of Hits

Local thunderstorm activity determines the total number of flashes any given structure is exposed to. Statistics are kept on the number of days thunder is heard in any location. This is termed the isokeraunic level. Long term averages of thunderstorm activity are projected on an isokeraunic map. The total number of strikes a structure will receive can't be precisely determined but can be predicted by considering variables such as local terrain, the shape and composition of a structure, nearby structures or trees, and the overall local overall frequency of thunderstorms. In addition to isokeraunic level, the density of flashes to ground in a typical storm can be calculated per square kilometer according to local latitude. Not all spots within a general area have an equal probability of collecting lightning strokes. An elevated structure or natural elevation collects lightning. Anything rising above the prevailing terrain protects a circle of earth with a radius of about three times the height of the projection.

The effective height, the height of a structure plus the elevation of the hilltop it stands on, is what will determine the likelihood of a lightning strike. The higher the structure relative to its surroundings, the more often it gets hit by lightning. One square foot in a square mile of real estate in an area that typically experiences four hits per square mile per year would be hit by lightning about once every seven million years. With a 200-ft tower on that spot, the odds change dramatically. The tower gathers in a million square feet worth of lightning,

and one event every six years is now a reasonable estimate. If this tower is set on a 400-ft rise, it can attract a lightning hit every seven or eight months.

Lightning will strike anything in its path. It more likely will choose a good conductor but will strike the best conductor it can find. If a metal and wood object are close together, lightning will most likely choose the metal. But, if they are far enough apart, they are equally vulnerable to a strike. Lightning current will flow through a good conductor and cause little damage, such as a minor deformity at the tip of a lightning rod or small melted area on intercepting cable. If lightning strikes a poor conductor, like wood, current will flow either over the object's surface and cause little damage or through it and cause severe damage, such as splintering a tree (it seems particularly fond of pines).

Damage to Buildings and Equipment

Lightning produces two kinds of damaging currents. Stroke current, generated by cloud-to-ground lightning, produces direct effects, and distributed ground currents, which can be caused by lightning within a cloud, produce indirect effects.

The direct effects of lightning strikes include shattering of wood, windows, masonry and other poorly conductive materials. A lightning channel can generate over 27,000 °C (hotter than the surface of the sun) and ignite fires. The stroke current of a lightning hit to a tower or power feed can travel into an equipment cabinet and burn out electrical power and distribution equipment and cause power distribution transformers to explode. Engineers tell stories of equipment chassis exploding and burning and wall mounted equipment being blown off the wall.

The indirect effects of lightning come from earth-voltage rises when a flash dumps thousands of amperes into the earth and the electromagnetic fields generated by lightning stroke currents. The resulting induced voltage can burn out equipment connected by electric power and signal circuits. Solid state electronics are particularly vulnerable. Above or below ground cables that connect several buildings or installations can receive induced voltage transients from lightning several kilometers away. Damaging surges can be transferred into a building from power, telephone, and data lines

Lightning Protection of Transmission Lines

and underground plumbing. Even nonconductive fiber optic signal lines can attract lightning if they have conductive metal sheaths. The blast pressures can crush the optical fibers.

When insulating or semi-insulating material receives a discharge, an explosive reaction can cause the damage. Steel towers, although more resistant to lightning damage, are still vulnerable where structural steel support members or steel reinforcing rods are encased in concrete, brick, or marble, and the structure has inadequate lightning protection.

Rise Times and Current Levels

It all starts with the lightning stroke. A single display of lightning, the "flash," is made up of individual strokes - as few as one and typically two or three. The stroke current from cloud-to-ground lightning starts at zero, rapidly rises to its peak, then more slowly decays back to zero. Peak amplitude declines with successive strokes. The duration of an entire sequence is only one-third to one-half second. The rise time is about two microseconds and the decay to 50% of peak amplitude is about 40 microseconds. Despite the short rise time, the delivered current is astounding. Research has demonstrated that 50% of the strokes measured peaked at 18,000 amperes, 10% exceeded 60,000 amperes, and 1% exceeded 120,000 amperes. It is the fast rise time and high peak amplitude current of the lightning stroke that produces the severe mechanical, thermal, and electrical effects. The stroke generates a constant-current circuit that delivers every ampere to the low impedance point struck on the earth.

Communications systems are highly vulnerable to the effects of lightning, with the top of a base station antenna the most vulnerable. Stroke current can flow down both the outer and inner conductors of coaxial cable and may cause microscopic pits in coaxial cable shielding that can compromise signal quality. The operating lifetime of components can be shortened because of overstress. This type of damage can be prevented or minimized by properly using field-proved methods of lightning protection.

Protective Measures

Grounding, bonding, shielding, and surge suppression are the four commonly applied methods to protect from

indirect effects of lightning. The first step is to identify what needs to be protected and the paths that lightning currents and voltages can use to reach equipment. Grounding, bonding, and shielding reduce surges by providing additional paths for lightning currents to flow to earth. Surge suppression is important for critical, sensitive equipment and equipment connected by cables over long distances.

Protecting RF equipment investment and revenue from lightning damage requires proper transmission line grounding. An unprotected transmission line is a conduit to radio equipment for lightning transients. Installing both grounding kits and surge arrestors will help manage lightning effectively to safeguard equipment.

Grounding Kits

The first line of defense against the damaging effects of lightning is the grounding kit that is attached to transmission lines at various points along the cable support structure. In essence, grounding funnels lightning transients off the line's outer conductor. Each transmission line, at minimum, should be grounded at the top and bottom of the vertical run and at the entrance to the equipment shelter. For longer vertical runs, additional grounding should be installed at 60-m (200-ft) intervals.

Durable Design. Ground strap connections must withstand extreme outdoor conditions and still maintain solid mechanical connections to maximize protection. The key is to maintain low electrical contact resistance. A well designed grounding kit should conform to industry standards such as IEC 1024-1, Protection of Structures Against Lightning, and MIL-STD-188-124A, Military Standard for Grounding, Bonding, and Shielding. Some specific requirements of these standards include:

- A 16mm² cross sectional area for copper bonding conductors
- Galvanically compatible bonds
- Cleaned bonding surfaces
- Resistance of less than 1 milliohm per bond
- Encapsulated bonded surfaces

The requirements for encapsulated bonds is critical to both product design and installation. Moisture infiltration will speed corrosion, increase resistance, and lessen

the effectiveness of the grounding kit. The point most vulnerable to corrosion is where the grounding is attached to the transmission line. A good grounding kit will supply adequate sealing materials, such as butyl rubber and plastic tapes, to seal this connection. Grounding products with braided wire conductors are likely to have corrosion problems as the capillary action of the conductor wicks moisture into the connection.

Installation. Proper installation of grounding is essential to establish a reliable, low impedance path for lightning current. After determining the location for grounding, a small section of cable jacketing must be removed to accept the cable attachment strap. In wet conditions, the exposed outer conductor should be dried immediately before attaching the strap. When attaching the strap, all hardware must be tightened according to manufacturer specifications. Overtightening must be avoided to prevent cable damage that may result in greater system return loss. Good grounding kit design uses calibrated straps, expansion joints, or spring clips to help ensure proper tightness. The grounding kit must be sized for the cable being installed.

When attaching to the tower or ground bar, the downconductor should be as short as possible and oriented as straight downward as possible. Long and/or curved leads increase impedance and reduce grounding kit effectiveness.

As mentioned, grounding kit connections must be kept dry to prevent corrosion and reduce effectiveness. Weatherproofing materials should be part of each grounding kit and must be properly applied. Butyl rubber and plastic tapes have been used for many years and have been proven effective in thousands of installations. Recently, rubber boots and plastic enclosures have been introduced on some manufacturer's grounding kits to provide this essential weather protection. These kits will add a measure of convenience for the installer.

The final requirement in the ground kit installation is attachment of the termination lug. A small section of jacketing must be carefully removed from the copper conductor to avoid nicking, then the lug must be screwed or crimped in place. Crimp lugs should be sealed to the conductor with heat shrink tubing. The ground wire terminal can be attached to a tower member, bus bar, angle adapter attached to a tower

member, or tower downconductor. The use of hose clamps to attach ground terminals is not recommended. Aviation color paint, but not the zinc plating underneath it on the tower, or oxidation from the surface of the bus bar should be removed in the area where the termination lug will be bolted. A layer of conductive grease applied to this area will ensure good electrical contact when the lug is bolted into place.

Surge Arrestors

Sensitive microwave equipment requires an additional measure of protection against lightning transients. In these cases, surge arrestors are installed to remove transient current that may be induced onto the inner conductor of coaxial cable before it reaches the equipment.

Quarterwave shorting stub (QWS) and gas tube (spark gap) surge technologies have been proven very effective in RF applications. Each has unique characteristics that lend themselves to certain applications better than others. The proper surge arrestor for a given application adds the final level of lightning protection to a transmission line system.

The QWS surge arrestor operates similar to a bandpass filter, where a tuned stub shorts the center conductor of the device to its body, allowing only a specified frequency range to pass. This shorting stub is effectively one-quarter wavelength in size at the center of the desired frequency band. When a lightning surge with typical frequencies lower than 160 kHz enters a QWS arrestor, it sees the quarterwave stub as a direct path to the outer conductor and earth ground.

Since QWS arrestors are frequency specific, they exhibit low VSWR and low insertion loss, but they must be matched to the system's frequency of operation. They react instantly to a lightning surge but allow a small level of energy proportional to the magnitude of the lightning strike to pass (throughput energy). The heavy duty construction of the shorting stub provides high operating power handling capability and is known for its ability to survive multiple lightning strokes, making it ideal for high power and/or lightning prone sites. The QWS arrestor, however, cannot be used in applications that require a dc bias.

Lightning Protection of Transmission Lines

Gas tube surge arrestors also divert lightning current off the center conductor of a coaxial cable. This technology differs in that it allows passage of a wide frequency band, typically 0-2500 MHz, making it ideal for applications that use tower top devices that require a dc bias fed through the center conductor of the coax.

Where the QWS arrestor is frequency sensitive, the gas tube arrestor is voltage sensitive. The gas tube device appears as open until a specified voltage threshold is reached at which time it changes to a low impedance surge arresting state. Again, a small amount of throughput energy will pass as a finite amount of time is required for the fast rising current of a lightning surge to activate the gas tube.

Because the gas tube arrestor is voltage sensitive, average operating power is influenced by gas tube selection. It is important to follow manufacturer recommendations on gas tube selection to achieve the proper power rating for a given system.

Gas tube surge arrestors are typically rated to protect against lightning impulses up to 20 kA. Since there is no way of knowing whether or not a gas tube may be compromised from a high level lightning surge, periodic maintenance is required to replace surge arrestors or the gas tubes (arrestors with replaceable gas tubes) at locations of a suspect lightning strike.

Surge arrestors are available with common interfaces such as 7-16 DIN or Type N for easy integration into any transmission line system and should be installed on all transmission lines as close as possible to the equipment they are intended to protect. Systems that use tower top-mounted amplifiers should have a surge arrestor installed at the top and bottom of the coax run.

Prior to installation, all grounding surfaces should be cleaned and free of oxidation. Most surge arrestors

ground through their body. Some use a keyed bulkhead, while others depend on a flange or stud that must be fastened with provided hardware to the site's grounding system. A popular practice is to fasten the grounding mechanism on all surge arrestors to a single copper bulkhead or multiple copper bus bars, both of which are bonded to a master bus bar and earth ground. Proper torque must be applied to the hardware on the arrestor-to-grounding bar connection to ensure a low resistance connection. A special washer is often included with bulkhead mounting arrestors to help achieve this. A new washer should be installed whenever the arrestor is reinstalled after removal for system maintenance.

The lightning management practices described above for RF transmission lines are just a part of a complete site grounding plan. Towers, guy anchors, fences, telco and ac power lines, and other equipment within the site must also be tied into an earth grounding system. Many manufacturers of radio equipment outline specific requirements on the use of buried conductors, placement of ground rod, and bonding of connections. Following their requirements to achieve a low resistance earth grounding system is vital to the overall effectiveness of lightning management.

Conclusion

Lightning will strike twice, and it will frequently choose communications sites because of geographic location and tower height. A single system may experience over 100 strikes per year. Consequently, the need for protecting expensive radio equipment against the destructive power of lightning is crucial. Through good grounding practices, this threat can be managed effectively. Properly grounded RF transmission lines combined with surge arrestors tied into a well designed earth grounding system will help ensure that lightning goes to ground before it goes through RF equipment.

Appendix 9 Replaceable Gas Tube Surge Arrestors

Offering broadband performance from 0-2500 MHz and excellent electrical characteristics, Arrestor Plus® Replaceable Gas Tube Surge Arrestors are easy to install and feature a dc pass capability through the center conductor to power tower-top electronics. The unit's removable cap makes periodic maintenance fast and easy.

Ordering Information

Interface Type	Gas Tube Static Sparkover Voltage	Type Number
Bulkhead 7-16 DIN Female and 7-16 DIN Female	90 350	APG-BDFDF-090 APG-BDFDF-350
Bulkhead 7-16 DIN Female and 7-16 DIN Male	90 350	APG-BDFDM-090 APG-BDFDM-350
Bulkhead Type N Female and Type N Female	90 350	APG-BNFnF-090 APG-BNFnF-350
Bulkhead Type N Female and Type N Male	90 350	APG-BNFnM-090 APG-BNFnM-350

Gas Tube Replacement Kit of 10

Static Sparkover Voltage	Type Number
90	GASTUBE-090
350	GASTUBE-350

Appendix 10 Fire Retardant Cables and Waveguides

Fire Retardance Requirements

Cable and waveguide installed inside a building usually must meet fire retardance requirements. In the United States, the National Electrical Code (NEC)* sets the standard for coaxial cable used within buildings and normally has the force of law, as most local electrical codes in the U.S. are based on it. In addition, most building codes cover cable, and other local requirements may exist such as the Fire Gas Toxicity Standards of New York State. Somewhat similar requirements are provided by the Canadian Electrical Code (CEC), issued by the Canadian Standards

Association (CSA). Other countries' requirements often reference the International Electrotechnical Commission (IEC) standards. Definitions Some terms used in building construction are referred to in fire-retardant cable regulations. They are defined below:

Conduit. A tube or duct for enclosing electrical wires and cable. Conduit may be metallic or nonmetallic.

Duct. A closed channel, tube, or pipe used to transport air, dust, vapors, etc.

Plenum. A compartment or chamber to which one or more air ducts are connected and forms part of the air distribution system of a building.

Raceway. An enclosed channel designed expressly for holding wires, cables, or bus bars, with additional functions as permitted in the National Electrical Code. Raceway may be metallic or nonmetallic.

Riser. A vertical shaft passing from floor to floor. Risers mayor may not be fireproof or have firestops at each floor.

Coaxial Cable Applications Defined by the NEC

In the National Electrical Code, coaxial cable falls under the Community Antenna Television Systems (CATV) category. The NEC provides requirements for coaxial cable installed within buildings in Article 820. These requirements cover all installations except where the cable enters the building from the outside, does not pass through a plenum or riser, and is (a) of any length, but runs throughout in a properly grounded metal conduit (rigid or intermediate) or (b) no longer than 50 feet (15.2 m), within the building, and terminated at a grounding block. The requirements state that these cables shall be listed as being resistant to the spread of fire as specified in the code, listed as being suitable for the purpose, and properly marked.

Four categories of listed coaxial cable are defined (in descending order of fire-resistance rating): Type CATVP, plenum cable; Type CATVR, riser cable; Type CATV, general purpose coaxial cable; and Type CATVX, limited use coaxial cable.

Wiring in Ducts, Plenums and Other Air-Handling Spaces

Only Type CATVP listed cables, which have extremely high fire resistance coupled with low smoke emission, are permitted by the NEC to be installed in ducts, plenums or other spaces used for environmental air

* National Electrical Code® and NEC® are registered trademarks of the National Fire Protection Association.

Surge Arrestors, Flame Retardant Cables and Waveguides

(such as above a false ceiling) without additional protection. All other cables, which must be listed as Type CATVX or higher, must be contained within rigid metal conduit, flexible metallic tubing or similar barrier, depending on the application. (These conditions preclude use of RADIAX® cables, so these cables must be CATVP listed to be installed in a plenum or duct).

Wiring In Vertical Runs

Type CATVR listed cables are required for installation in risers or any other floor penetration connecting more than one floor. Type CATVP cables, which have even higher fire resistance, can be substituted for Type CATVR cables. CATV or CATVX listed cables can also be installed in risers provided that they are encased in noncombustible tubing (not applicable to RADIAX cables) or are located in a fireproof shaft having firestops at each floor.

General Purpose Wiring Within Buildings

All coaxial cables to be installed within buildings in locations other than plenums and risers, as defined above, must be at least Type CATV listed for fire resistance unless one of the following exceptions applies:

- Type CATVX cable enclosed in raceway.
- Type CATVX cable in nonconcealed spaces where the exposed length does not exceed 10 ft (3.05 m).
- Small diameter Type CATVX cables installed in dwellings.

Type CATVR and Type CATVP cables, which have passed more stringent tests, are permitted to be substituted for Type CATV cables.

Model Building Code Requirements for Coaxial Cable

Some model building and mechanical codes also include fire retardance requirements for coaxial cable. Generally, they stipulate that exposed cables in concealed spaces over suspended ceilings, and other

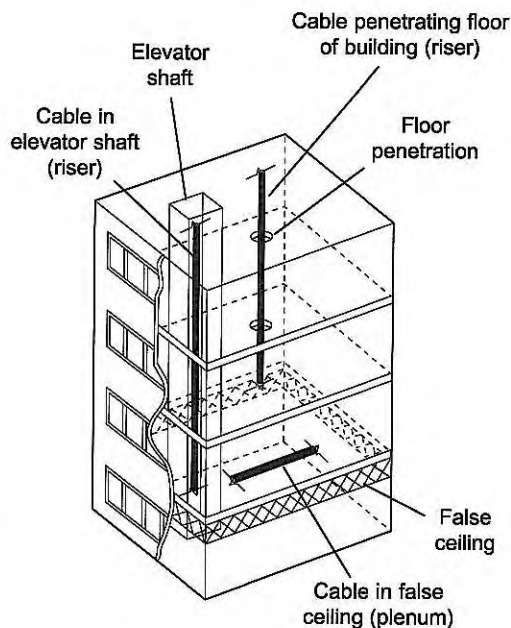

Riser and Plenum Applications in Multistory Building

spaces used for environmental air handling purposes as defined in the particular code, be listed and labeled as plenum cable per NEC requirements.

Fire Gas Toxicity

Fire Retardant Jacketing

Characteristics. Some coaxial cables use halogenated polymeric jacketing to provide fire retardance. (Halogens are chemically related elements such as fluorine, chlorine, and bromine.) The drawback to such materials is increased levels of smoke and toxic gases under fire.

All HELIAX® Coaxial Cables rated Type CATVR achieve fire retardance by using non-halogenated jacketing. While such a jacketing has low toxicity characteristics when burned, it is somewhat less effective at high temperatures than halogenated

jacketing. Presently, it is not possible to achieve the highest fire retardance rating, CATVP, without either employing halogenated jacketing or omitting the jacket entirely; consequently, Type CATVP listed HELIAX cables presently use halogenated fire retardant jacketing.

Caution: Since local requirements may vary, check with your local building inspector to make certain that a proposed installation conforms with all applicable electrical codes, building codes, mechanical codes and fire protection codes.

Andrew Fire Retardant Cables - Indoors or Outdoors

Andrew offers a full line of fire retardant products for HELIAX® coaxial cable, RADIAX® radiating coaxial cable and HELIAX elliptical waveguide. A listing of these products is given in the Andrew general catalog.

Fire retardant cables are suitable for indoor or outdoor use. Outdoor service life is 10 years, minimum, for HELIAX cables with CATVR (RN) rated jacketing. CATVP (RP) rated cables have an even longer outdoor service life.

Appendix 11

Radio Frequency (RF) Communications Basics

There are many forms of RF communications in everyday life:

- AM and FM radio
- Ship-to-shore, aircraft, and ham radio
- Television broadcast and CATV
- Computer information systems, data, and voice transfer
- Landline and cellular telephones

RF communications technology is a vital and necessary part of modern life. People, businesses, and governments need and rely on dependable, high-quality RF communication systems. Emergency communications systems save lives, secure communications, and enable transactions for businesses. Electronic funds transfer is a key function of most financial institutions. People like to stay in touch with family, coworkers, and emergency contacts via cellular phones and computers.

Communications Equipment Installers are an important element of the communications team. They enable the various communication technologies mentioned above that have one thing in common: they all use radio frequency electromagnetic wave energy to carry signals from one point to another.

Electromagnetic energy includes different types of radiation energy. It is energy that travels and spreads out - or radiates - as it travels. Together, the wide range of electromagnetic energy frequencies make up the electromagnetic spectrum. Types of electromagnetic energy include: radio and television waves, microwaves, infrared and visible light, ultraviolet light, X-rays, and Gamma rays. These forms of energy are very different, but they are all basically the same; that is, electromagnetic radiation.

The RF communications band is only a small part of the full electromagnetic spectrum. The RF band is well below the frequencies of microwave or visible light, and is much higher than the frequencies of audible sound. Sound is not an electromagnetic energy; it is mechanical vibration of a material medium such as air. RF energy can be transmitted freely through the air, radiating outward at the speed of light (186,284 miles per second). It can also be transmitted within confined media, such as wire or coaxial cable. Coaxial cable and waveguide provide a sealed environment that allows

signals to travel directly from a source to a receiver.

RF waves are measurable. Electromagnetic radiation travels at the speed of light in a wave-like pattern. Each of the different electromagnetic signals is measured in terms of frequency (measured in units called "hertz") and wavelength.

Frequency is the number of electromagnetic waves that pass a given point in one second. Hertz is the standard unit of measurement for frequency. One hertz is equal to one cycle, or wave, per second. An audio signal of 100 hertz (Hz) has one hundred waves per second passing a given point. A signal measuring 1,000 hertz, or 1 kilohertz (kHz), has a thousand waves per second passing a point. A million waves per second is 1 megahertz (MHz). A billion waves per second is 1 gigahertz (GHz).

A wave is measured from the peak of one wave to the peak of the next. This distance is called the wavelength. A higher signal frequency has a shorter wavelength. The frequency defines where a signal is on the electromagnetic spectrum and amplitude defines how strong that signal is. The greater the distance between the peak of a wave and its trough, the greater the strength or amplitude. Changes in amplitude have no effect on frequency. The signal strength is as the power in the signal referenced to a baseline, 1 watt or 1 milliwatt. Usually a logarithmic scale (decibels) is used. If the baseline is 1 milliwatt, the signal strength is expressed as dBm.

The use of coaxial cable, and the quality of signal attenuation play an important role in signal transmission. Attenuation is a reduction in signal power. It's like a flashlight beam shining through fog. It is diminished and diffused as it moves farther from the source. Attenuation occurs as the signal travels through a transmission medium, such as coaxial cable or waveguide. Attenuation is measured in decibels (dB), and can be calculated as a logarithmic ratio between power in and power out of a system. It is generally the most important factor in the overall performance and efficiency of a transmission line.

System designers always consider attenuation rates in coaxial cable when planning a system. Equipment

RF Communications Basics, Conversion Table

installers should also be familiar with the system for measuring and managing attenuation. When designers talk about loss or attenuation, they don't use the negative sign (a loss of 3 dB, etc.). However, the output power is always less than the input power by the number of dB, so if in a measurement we reference the input power to zero dB, the output power will show a negative dB value. Attenuation is typically measured as a dB number indicating a loss of signal. For example: a minus 3 dB reading with a power input of 0 dB tells us that the system is at only half the power level coming out as was coming in. This represents a 50% loss of power. A minus 10 dB reading with a power input of 0 dB means that power out is 1/10th the power in. A minus 20 dB reading with a power input of 0 dB means that power out is 1/100th the power in.

Attenuation in a coaxial cable depends on the dimensions and the material characteristics of the cable itself. Material properties are not controllable by the

cable manufacturer, but designs are optimized to give the best balance of electrical and mechanical properties. Sources of attenuation in cable include the diameter of the cable. Generally, the larger the cable, the lower the attenuation. Another source is the length of the cable. The longer the cable span, the greater the attenuation. Conductivity of the conductor material must be considered. Copper, for example, is a more conductive material than aluminum. Also dielectric material, which means that different materials allow signal to move with varying degrees of transparency through the cable.

Additional sources of attenuation in cable that can be controlled by manufacturers or installers include cracks or other openings in the cable outer conductor. Signal loss through these openings can cause attenuation and interference with over-the-air transmissions. Connector installation error can result in loss from gaps or voids that allow signal leakage, water leakage, etc.

Appendix 12 Conversion Tables

ELECTRICAL FORMULAS

1 millimeter	= 0.039370 inch
1 centimeter	= 0.032808 foot = 0.39370 inch
1 meter	= 3.280833 feet = 39.3700 inches
1 foot	= 0.3048006 metre
1 inch	= 2.540005 centimeter = 25.40005 millimeters
1 gram	= 0.00220462 pound = 0.0352740 ounces
1 pound	= 0.453592 kilogram = 453.5924 grams
1 ounce	= 28.349527 grams

(Note: Pounds/Ounces Avoirdupois)

TEMPERATURE CONVERSION

$$F^{\circ} = (1.8 \times C^{\circ}) + 32$$

$$C^{\circ} = \frac{(F^{\circ} - 32)}{1.8}$$

Appendix 13 Cable Hanger Spacing

Cable Hanger Spacing

Recommended maximum hanger spacings are tabulated below for various wind speed and ice conditions. The recommendations are based on guidelines stated in EIA Standard RS-222 and new wind tunnel and vibration tests. They are current as of January 2003 and supersede those in previous Andrew Catalogs. Please refer to Andrew publication number 10883 available at www.andrew.com for the most current recommendations.

These spacing recommendations assume that all hangers are properly installed and tightened.

Installations in Typical Climates. Use the 125 mph (200 km/h), 1/2" ice conditions.

Severe or Mild Climates. Use the wind speed and ice conditions that most closely approximate the expected worst case conditions for the local climate.

Standard Hangers - Maximum Hanger Spacing (Note: Standard tower configuration spacing is 3 to 4 ft.)

Cable Size	Cable Type Number	Hanger Type Number	Recommended Maximum Hanger Spacing, feet (meters)					
			85 mph (137 km/h)			100 mph (160 km/h)		
			Wind Speed: Radial Ice:	No Ice	1/2" (13mm)	1" (25mm)	No Ice	1/2" (13mm)
1/2"	LDF4-50A	43211A	5 (1.5)	4 (1.2)	3 (0.9)	5 (1.5)	4 (1.2)	3 (0.9)
1/2"	LDF4-75A	43211A	5 (1.5)	4 (1.2)	3 (0.9)	5 (1.5)	4 (1.2)	3 (0.9)
1/2"	HL4RP-50	43211A	5 (1.5)	4 (1.2)	3 (0.9)	5 (1.5)	4 (1.2)	3 (0.9)
1/2"	HJ4-50	43211A	5 (1.5)	4 (1.2)	3 (0.9)	5 (1.5)	4 (1.2)	3 (0.9)
1/2"	HLT4-50	43211A	5 (1.5)	4 (1.2)	3 (0.9)	5 (1.5)	3 (0.9)	2 (0.6)
1/2"	HT4-50	43211A	5 (1.5)	4 (1.2)	3 (0.9)	5 (1.5)	4 (1.2)	3 (0.9)
1/2"	HST4-50	43211A	5 (1.5)	3 (0.9)	3 (0.9)	4 (1.2)	3 (0.9)	2 (0.6)
1/2"	HS4RP-50	43211A	5 (1.5)	3 (0.9)	3 (0.9)	4 (1.2)	3 (0.9)	2 (0.6)
1/2"	FSJ4-50B	43211A	5 (1.5)	3 (0.9)	3 (0.9)	4 (1.2)	3 (0.9)	2 (0.6)
1/2"	FSJ4-75A	43211A	5 (1.5)	3 (0.9)	3 (0.9)	4 (1.2)	3 (0.9)	2 (0.6)
5/8"	LDF4.5-50	42396A-9	5 (1.5)	5 (1.5)	4 (1.2)	5 (1.5)	5 (1.5)	4 (1.2)
5/8"	HJ4.5-50	42396A-9	5 (1.5)	5 (1.5)	4 (1.2)	5 (1.5)	5 (1.5)	4 (1.2)
7/8"	LDF5-50A	42396A-5	5 (1.5)	5 (1.5)	4 (1.2)	5 (1.5)	5 (1.5)	4 (1.2)
7/8"	HJ5-50	42396A-5	5 (1.5)	5 (1.5)	4 (1.2)	5 (1.5)	5 (1.5)	4 (1.2)
7/8"	HJ5-75	42396A-5	5 (1.5)	5 (1.5)	4 (1.2)	5 (1.5)	5 (1.5)	4 (1.2)
7/8"	HT5-50	42396A-5	5 (1.5)	5 (1.5)	4 (1.2)	5 (1.5)	5 (1.5)	4 (1.2)
1-1/4"	LDF6-50	42396A-1	4 (1.2)	4 (1.2)	4 (1.2)	4 (1.2)	4 (1.2)	3 (0.9)
1-5/8"	LDF7-50A	42396A-2	4 (1.2)	4 (1.2)	4 (1.2)	4 (1.2)	3 (0.9)	3 (0.9)
1-5/8"	HJ7-50A	42396A-2	4 (1.2)	4 (1.2)	4 (1.2)	4 (1.2)	3 (0.9)	3 (0.9)
2-1/4"	LDF12-50	42395A-4	4 (1.2)	4 (1.2)	4 (1.2)	4 (1.2)	3 (0.9)	3 (0.9)
2-1/4"	HJ12-50	42396A-4	4 (1.2)	4 (1.2)	4 (1.2)	4 (1.2)	3 (0.9)	3 (0.9)
3"	HJ8-50B	31766A-11	5 (1.5)	5 (1.5)	5 (1.5)	5 (1.5)	5 (1.5)	5 (1.5)
4"	HJ11-50B	31766A-10	5 (1.5)	5 (1.5)	5 (1.5)	5 (1.5)	5 (1.5)	5 (1.5)
5"	HJ9HP-50	33598-5	5 (1.5)	5 (1.5)	5 (1.5)	5 (1.5)	5 (1.5)	5 (1.5)
5"	HJ9-50	33598-5	5 (1.5)	5 (1.5)	5 (1.5)	5 (1.5)	5 (1.5)	5 (1.5)

Definitions and Assumptions 1. Per EIA-222 Standard: Coefficient of drag for coaxial cable is 1.2 (cylindrical members). Ice forms completely around member (360 degrees). Combined wind and ice loading is reduced by 25% to reflect lower probability of wind and ice occurring simultaneously. 2. Wind speeds are maximum, which includes gust factors and exposure factors.

Notes:

Appendixes

Cable Hanger Spacing

Standard Hangers - Maximum Hanger Spacing (Note: Standard tower configuration spacing is 3 to 4 ft.)

Cable Size	Cable Type Number	Hanger Type Number	Recommended Maximum Hanger Spacing, feet (meters)					
			125 mph (200 km/h)			150 mph (240 km/h)		
			Wind Speed: Radial Ice:	No Ice	1/2" (13mm)	1" (25mm)	No Ice	1/2" (13mm)
1/2"	LDF4-50A	43211A	4 (1.2)	3 (0.9)	2 (0.6)	3 (0.9)	2 (0.6)	1 (0.3)
1/2"	LDF4-75A	43211A	4 (1.2)	3 (0.9)	2 (0.6)	3 (0.9)	2 (0.6)	1 (0.3)
1/2"	HL4RP-50	43211A	4 (1.2)	3 (0.9)	2 (0.6)	3 (0.9)	2 (0.6)	1 (0.3)
1/2"	HJ4-50	43211A	4 (1.2)	3 (0.9)	2 (0.6)	3 (0.9)	2 (0.6)	1 (0.3)
1/2"	HLT4-50	43211A	4 (1.2)	3 (0.9)	2 (0.6)	3 (0.9)	2 (0.6)	1 (0.3)
1/2"	HT4-50	43211A	4 (1.2)	3 (0.9)	2 (0.6)	3 (0.9)	2 (0.6)	1 (0.3)
1/2"	HST4-50	43211A	3 (0.9)	2 (0.6)	2 (0.6)	3 (0.9)	2 (0.6)	1 (0.3)
1/2"	HS4RP-50	43211A	3 (0.9)	2 (0.6)	2 (0.6)	3 (0.9)	2 (0.6)	1 (0.3)
1/2"	FSJ4-50B	43211A	3 (0.9)	2 (0.6)	2 (0.6)	3 (0.9)	2 (0.6)	1 (0.3)
1/2"	FSJ4-75A	43211A	3 (0.9)	2 (0.6)	2 (0.6)	3 (0.9)	2 (0.6)	1 (0.3)
5/8"	LDF4.5-50	42396A-9	5 (1.5)	4 (1.2)	3 (0.9)	4 (1.2)	3 (0.9)	3 (0.9)
5/8"	HJ4.5-50	42396A-9	5 (1.5)	4 (1.2)	3 (0.9)	4 (1.2)	3 (0.9)	3 (0.9)
7/8"	LDF5-50A	42396A-5	5 (1.5)	4 (1.2)	3 (0.9)	4 (1.2)	3 (0.9)	2 (0.6)
7/8"	HJ5-50	42396A-5	5 (1.5)	4 (1.2)	3 (0.9)	4 (1.2)	3 (0.9)	2 (0.6)
7/8"	HJ5-75	42396A-5	5 (1.5)	4 (1.2)	3 (0.9)	4 (1.2)	3 (0.9)	2 (0.6)
7/8"	HT5-50	42396A-5	5 (1.5)	4 (1.2)	3 (0.9)	4 (1.2)	3 (0.9)	2 (0.6)
1-1/4"	LDF6-50	42396A-1	4 (1.2)	4 (1.2)	3 (0.9)	3 (0.9)	3 (0.9)	3 (0.9)
1-5/8"	LDF7-50A	42396A-2	3 (0.9)	3 (0.9)	3 (0.9)	3 (0.9)	3 (0.9)	2 (0.6)
1-5/8"	HJ7-50A	42396A-2	3 (0.9)	3 (0.9)	3 (0.9)	3 (0.9)	3 (0.9)	2 (0.6)
2-1/4"	LDF12-50	42395A-4	3 (0.9)	3 (0.9)	3 (0.9)	3 (0.9)	3 (0.9)	3 (0.9)
2-1/4"	HJ12-50	42396A-4	3 (0.9)	3 (0.9)	3 (0.9)	3 (0.9)	3 (0.9)	3 (0.9)
3"	HJ8-50B	31766A-11	5 (1.5)	5 (1.5)	5 (1.5)	5 (1.5)	5 (1.5)	5 (1.5)
4"	HJ11-50B	31766A-10	5 (1.5)	5 (1.5)	5 (1.5)	5 (1.5)	5 (1.5)	5 (1.5)
5"	HJ9HP-50	33598-5	5 (1.5)	5 (1.5)	5 (1.5)	5 (1.5)	5 (1.5)	5 (1.5)
5"	HJ9-50	33598-5	5 (1.5)	5 (1.5)	5 (1.5)	5 (1.5)	5 (1.5)	5 (1.5)

Definitions and Assumptions 1. Per EIA-222 Standard; Coefficient of drag for coaxial cable is 1.2 (cylindrical members). Ice forms completely around member (360 degrees). Combined wind and ice loading is reduced by 25% to reflect lower probability of wind and ice occurring simultaneously. 2. Wind speeds are maximum, which includes gust factors and exposure factors.

Notes:

Snap-In Hangers - Recommended Maximum Hanger Spacing

Cable Size	Cable Type Number	Hanger Type Number	Recommended Maximum Hanger Spacing, feet (meters)					
			85 mph (137 km/h)			100 mph (160 km/h)		
			Wind Speed: Radial Ice:	No Ice	1/2" (13mm)	1" (25mm)	No Ice	1/2" (13mm)
1/2"	LDF4-50A	SSH-12	4 (1.22)	4 (1.22)	3 (0.91)	4 (1.22)	3 (0.91)	2 (0.61)
1/2"	LDF4-75	SSH-12	4 (1.22)	4 (1.22)	3 (0.91)	4 (1.22)	3 (0.91)	2 (0.61)
1/2"	FSJ4-50B	SSH-12	4 (1.22)	3 (0.91)	2 (0.61)	3 (0.91)	2 (0.61)	2 (0.61)
1/2"	FSJ4-75A	SSH-12	4 (1.22)	3 (0.91)	2 (0.61)	3 (0.91)	2 (0.61)	2 (0.61)
1/2"	HL4RP-50	SSH-12	4 (1.22)	4 (1.22)	3 (0.91)	4 (1.22)	3 (0.91)	2 (0.61)
1/2"	HLT4-50	SSH-12	4 (1.22)	4 (1.22)	3 (0.91)	4 (1.22)	3 (0.91)	2 (0.61)
1/2"	HS4RP-50	SSH-12	4 (1.22)	4 (1.22)	3 (0.91)	4 (1.22)	3 (0.91)	2 (0.61)
1/2"	HST4-50	SSH-12	4 (1.22)	4 (1.22)	3 (0.91)	4 (1.22)	3 (0.91)	2 (0.61)
1/2"	HT4-50	SSH-12	4 (1.22)	4 (1.22)	3 (0.91)	4 (1.22)	3 (0.91)	2 (0.61)
1/2"	HJ4-50	SSH-12	4 (1.22)	4 (1.22)	3 (0.91)	4 (1.22)	3 (0.91)	2 (0.61)
5/8"	LDF4.5-50	206706A-6	4 (1.22)	4 (1.22)	3 (0.91)	4 (1.22)	3 (0.91)	2 (0.61)
7/8"	LDF5-50A	SSH-78	4 (1.22)	3 (0.91)	3 (0.91)	3 (0.91)	3 (0.91)	2 (0.61)
7/8"	HJ5-50	SSH-78	4 (1.22)	3 (0.91)	3 (0.91)	3 (0.91)	3 (0.91)	2 (0.61)
7/8"	HJ5-75	SSH-78	4 (1.22)	3 (0.91)	3 (0.91)	3 (0.91)	3 (0.91)	2 (0.61)
7/8"	HT5-50	SSH-78	4 (1.22)	3 (0.91)	3 (0.91)	3 (0.91)	3 (0.91)	2 (0.61)
7/8"	FT5-50T	SSH-78	4 (1.22)	3 (0.91)	3 (0.91)	3 (0.91)	3 (0.91)	2 (0.61)
1-1/4"	LDF6-50	SSH-114	3 (0.91)	3 (0.91)	3 (0.91)	3 (0.91)	3 (0.91)	2 (0.61)
1-5/8"	LDF7-50A	SSH-158	3 (0.91)	3 (0.91)	3 (0.91)	3 (0.91)	3 (0.91)	2 (0.61)
1-5/8"	HJ7-50A	SSH-158	3 (0.91)	3 (0.91)	3 (0.91)	3 (0.91)	3 (0.91)	2 (0.61)
2-1/4"	LDF12-50	206706A-5	3 (0.91)	3 (0.91)	3 (0.91)	3 (0.91)	2 (0.61)	2 (0.61)
Cable Size	Cable Type Number	Hanger Type Number	Recommended Maximum Hanger Spacing, feet (meters)					
			125 mph (200 km/h)			150 mph (240 km/h)		
			Wind Speed: Radial Ice:	No Ice	1/2" (13mm)	1" (25mm)	No Ice	1/2" (13mm)
1/2"	LDF4-50A	SSH-12	3 (0.91)	3 (0.91)	2 (0.61)	3 (0.91)	2 (0.61)	1 (0.30)
1/2"	LDF4-75	SSH-12	3 (0.91)	3 (0.91)	2 (0.61)	3 (0.91)	2 (0.61)	1 (0.30)
1/2"	FSJ4-50B	SSH-12	3 (0.91)	2 (0.61)	1 (0.30)	2 (0.61)	2 (0.61)	1 (0.30)
1/2"	FSJ4-75A	SSH-12	3 (0.91)	2 (0.61)	1 (0.30)	2 (0.61)	2 (0.61)	1 (0.30)
1/2"	HL4RP-50	SSH-12	3 (0.91)	3 (0.91)	2 (0.61)	3 (0.91)	2 (0.61)	1 (0.30)
1/2"	HLT4-50	SSH-12	3 (0.91)	3 (0.91)	2 (0.61)	3 (0.91)	2 (0.61)	1 (0.30)
1/2"	HS4RP-50	SSH-12	3 (0.91)	3 (0.91)	2 (0.61)	3 (0.91)	2 (0.61)	1 (0.30)
1/2"	HST4-50	SSH-12	3 (0.91)	3 (0.91)	2 (0.61)	3 (0.91)	2 (0.61)	1 (0.30)
1/2"	HT4-50	SSH-12	3 (0.91)	3 (0.91)	2 (0.61)	3 (0.91)	2 (0.61)	1 (0.30)
1/2"	HJ4-50	SSH-12	3 (0.91)	3 (0.91)	2 (0.61)	3 (0.91)	2 (0.61)	1 (0.30)
5/8"	LDF4.5-50	206706A-6	3 (0.91)	3 (0.91)	2 (0.61)	2 (0.61)	2 (0.61)	1 (0.30)
7/8"	LDF5-50A	SSH-78	3 (0.91)	3 (0.91)	2 (0.61)	2 (0.61)	1 (0.30)	1 (0.30)
7/8"	HJ5-50	SSH-78	3 (0.91)	3 (0.91)	2 (0.61)	2 (0.61)	1 (0.30)	1 (0.30)
7/8"	HJ5-75	SSH-78	3 (0.91)	3 (0.91)	2 (0.61)	2 (0.61)	1 (0.30)	1 (0.30)
7/8"	HT5-50	SSH-78	3 (0.91)	3 (0.91)	2 (0.61)	2 (0.61)	1 (0.30)	1 (0.30)
7/8"	FT5-50T	SSH-78	3 (0.91)	3 (0.91)	2 (0.61)	2 (0.61)	1 (0.30)	1 (0.30)
1-1/4"	LDF6-50	SSH-114	3 (0.91)	3 (0.91)	2 (0.61)	2 (0.61)	1 (0.30)	1 (0.30)
1-5/8"	LDF7-50A	SSH-158	3 (0.91)	3 (0.91)	2 (0.61)	2 (0.61)	1 (0.30)	1 (0.30)
1-5/8"	HJ7-50A	SSH-158	3 (0.91)	3 (0.91)	2 (0.61)	2 (0.61)	1 (0.30)	1 (0.30)
2-1/4"	LDF12-50	206706A-5	2 (0.61)	2 (0.61)	1 (0.30)	2 (0.61)	1 (0.30)	1 (0.30)

Definitions and Assumptions 1. Per EIA-222 Standard: Coefficient of drag for coaxial cable is 1.2 (cylindrical members). Ice forms completely around member (360 degrees). Combined wind and ice loading is reduced by 25% to reflect lower probability of wind and ice occurring simultaneously. 2. Wind speeds are maximum, which includes gust factors and exposure factors.

Notes:

Appendixes

Cable Hanger Spacing

Click-On Hangers – Recommended Maximum Hanger Spacing

Cable Size	Cable Type	Hanger Type* Number and Stacking	Recommended Maximum Hanger Spacing, feet (meters)					
			85 mph (137 km/h)			100 mph (160 km/h)		
			Wind Speed: Radial Ice:	No Ice	1/2" (13mm)	1" (25mm)	No Ice	1/2" (13mm)
1/2"	LDF4-50A	L4CLICK, 1-Stack	3 (0.91)	3 (0.91)	3 (0.91)	3 (0.91)	3 (0.91)	3 (0.91)
1/2"	LDF4-50A	L4CLICK, 2-Stack	3 (0.91)	3 (0.91)	3 (0.91)	3 (0.91)	3 (0.91)	3 (0.91)
1/2"	LDF4-50A	L4CLICK, 3-Stack	3 (0.91)	3 (0.91)	3 (0.91)	3 (0.91)	3 (0.91)	3 (0.91)
Note: These same hanger spacing recommendations apply for the other following 1/2" cable types: LDF4-75A, HL4RP-50, HLT4-50, HS4RP-50, HST4-50, HT4-50, HJ4-50								
5/8"	LDF4.5-50	L45CLICK, 1-Stack	3 (0.91)	3 (0.91)	3 (0.91)	3 (0.91)	3 (0.91)	3 (0.91)
5/8"	LDF4.5-50	L45CLICK, 2-Stack	3 (0.91)	3 (0.91)	3 (0.91)	3 (0.91)	3 (0.91)	3 (0.91)
5/8"	LDF4.5-50	L45CLICK, 3-Stack	3 (0.91)	3 (0.91)	3 (0.91)	3 (0.91)	3 (0.91)	3 (0.91)
Note: These same hanger spacing recommendations apply for the other following 5/8" cable types: HJ4.5-50								
7/8"	LDF5-50A	L5CLICK, 1-Stack	4 (1.22)	4 (1.22)	4 (1.22)	3 (0.91)	3 (0.91)	3 (0.91)
7/8"	LDF5-50A	L5CLICK, 2-Stack	4 (1.22)	4 (1.22)	4 (1.22)	3 (0.91)	3 (0.91)	3 (0.91)
7/8"	LDF5-50A	L5CLICK, 3-Stack	4 (1.22)	4 (1.22)	4 (1.22)	3 (0.91)	3 (0.91)	3 (0.91)
Note: These same hanger spacing recommendations apply for the other following 7/8" cable types: VXL5-50, HJ5-50, HJ5-75, HT5-50								
1-1/4"	LDF6-50	L6CLICK, 1-Stack	4 (1.22)	4 (1.22)	4 (1.22)	3 (0.91)	3 (0.91)	3 (0.91)
1-1/4"	LDF6-50	L6CLICK, 2-Stack	4 (1.22)	4 (1.22)	4 (1.22)	3 (0.91)	3 (0.91)	3 (0.91)
1-1/4"	LDF6-50	L6CLICK, 3-Stack	3 (0.91)	3 (0.91)	3 (0.91)	3 (0.91)	3 (0.91)	3 (0.91)
1-5/8"	LDF7-50A	L7CLICK, 1-Stack	4 (1.22)	4 (1.22)	4 (1.22)	3 (0.91)	3 (0.91)	3 (0.91)
1-5/8"	LDF7-50A	L7CLICK, 2-Stack	3 (0.91)	3 (0.91)	3 (0.91)	3 (0.91)	3 (0.91)	3 (0.91)
1-5/8"	LDF7-50A	L7CLICK, 3-Stack	3 (0.91)	3 (0.91)	3 (0.91)	3 (0.91)	3 (0.91)	3 (0.91)
Note: These same hanger spacing recommendations apply for the other following 1 5/8" cable types: HJ7-50A								
Cable Size	Cable Type	Hanger Type* Number and Stacking	Recommended Maximum Hanger Spacing, feet (meters)					
			125 mph (200 km/h)			150 mph (240 km/h)		
			Wind Speed: Radial Ice:	No Ice	1/2" (13mm)	1" (25mm)	No Ice	1/2" (13mm)
1/2"	LDF4-50A	L4CLICK, 1-Stack	3 (0.91)	3 (0.91)	3 (0.91)	2 (0.61)	2 (0.61)	2 (0.61)
1/2"	LDF4-50A	L4CLICK, 2-Stack	3 (0.91)	3 (0.91)	3 (0.91)	2 (0.61)	2 (0.61)	2 (0.61)
1/2"	LDF4-50A	L4CLICK, 3-Stack	3 (0.91)	3 (0.91)	3 (0.91)	2 (0.61)	2 (0.61)	2 (0.61)
Note: These same hanger spacing recommendations apply for the other following 1/2" cable types: LDF4-75A, HL4RP-50, HLT4-50, HS4RP-50, HST4-50, HT4-50, HJ4-50								
5/8"	LDF4.5-50	L45CLICK, 1-Stack	3 (0.91)	3 (0.91)	3 (0.91)	2 (0.61)	2 (0.61)	2 (0.61)
5/8"	LDF4.5-50	L45CLICK, 2-Stack	3 (0.91)	3 (0.91)	3 (0.91)	2 (0.61)	2 (0.61)	2 (0.61)
5/8"	LDF4.5-50	L45CLICK, 3-Stack	2 (0.61)	2 (0.61)	2 (0.61)	2 (0.61)	2 (0.61)	2 (0.61)
Note: These same hanger spacing recommendations apply for the other following 5/8" cable types: HJ4.5-50								
7/8"	LDF5-50A	L5CLICK, 1-Stack	3 (0.91)	3 (0.91)	3 (0.91)	2 (0.61)	2 (0.61)	2 (0.61)
7/8"	LDF5-50A	L5CLICK, 2-Stack	3 (0.91)	3 (0.91)	3 (0.91)	2 (0.61)	2 (0.61)	2 (0.61)
7/8"	LDF5-50A	L5CLICK, 3-Stack	2 (0.61)	2 (0.61)	2 (0.61)	2 (0.61)	2 (0.61)	2 (0.61)
Note: These same hanger spacing recommendations apply for the other following 7/8" cable types: VXL5-50, HJ5-50, HJ5-75, HT5-50								
1-1/4"	LDF6-50	L6CLICK, 1-Stack	3 (0.91)	3 (0.91)	3 (0.91)	2 (0.61)	2 (0.61)	2 (0.61)
1-1/4"	LDF6-50	L6CLICK, 2-Stack	3 (0.91)	3 (0.91)	3 (0.91)	2 (0.61)	2 (0.61)	2 (0.61)
1-1/4"	LDF6-50	L6CLICK, 3-Stack	2 (0.61)	2 (0.61)	2 (0.61)	2 (0.61)	2 (0.61)	2 (0.61)
1-5/8"	LDF7-50A	L7CLICK, 1-Stack	3 (0.91)	3 (0.91)	3 (0.91)	2 (0.61)	2 (0.61)	2 (0.61)
1-5/8"	LDF7-50A	L7CLICK, 2-Stack	2 (0.61)	2 (0.61)	2 (0.61)	2 (0.61)	2 (0.61)	2 (0.61)
1-5/8"	LDF7-50A	L7CLICK, 3-Stack	2 (0.61)	2 (0.61)	2 (0.61)	2 (0.61)	2 (0.61)	2 (0.61)
Note: These same hanger spacing recommendations apply for the other following 1 5/8" cable types: HJ7-50A								

* These hanger spacings have been specified based on using the Click-On hangers with Andrew specified hardware kits.

Definitions and Assumptions 1. Per EIA-222 Standard: Coefficient of drag for coaxial cable is 1.2 (cylindrical members). Ice forms completely around member (360 degrees). Combined wind and ice loading is reduced by 25% to reflect lower probability of wind and ice occurring simultaneously. 2. Wind speeds are maximum, which includes gust factors and exposure factors.

Mini Click-On Hangers - Recommended Maximum Hanger Spacing

Cable Size	Cable Type Number	Hanger Type and Stacking	125 mph (200 km/h)		
			No Ice	1/2" (13mm)	1" (25mm)
6mm-8mm	CNT-240, CNT-300, FSJ1 series	68MCLICK, 1-Stack1	.5 (0.61)	1.5 (0.61)	1.5 (0.61)
6mm-8mm	CNT-240, CNT-300, FSJ1 series	68MCLICK, 2-Stack	1.5 (0.61)	1.5 (0.61)	1.5 (0.61)
6mm-8mm	CNT-240, CNT-300, FSJ1 series	68MCLICK, 3-Stack1	.5 (0.61)	1.5 (0.61)	1.5 (0.61)
9mm-12mm	CNT-400, LDF1, FSJ2, LDF2, EFX2 series	912MCLICK, 1-Stack	3 (0.91)	3 (0.91)	3 (0.91)
9mm-12mm	CNT-400, LDF1, FSJ2, LDF2, EFX2 series	912MCLICK, 2-Stack	3 (0.91)	3 (0.91)	3 (0.91)
9mm-12mm	CNT-400, LDF1, FSJ2, LDF2, EFX2 series	912MCLICK, 3-Stack	2 (0.61)	2 (0.61)	2 (0.61)
13mm-16mm	CNT-500, CNT-600, FSJ4, LDF4 series	1316MCLICK, 1-Stack	3 (0.91)	3 (0.91)	3 (0.91)
13mm-16mm	CNT-500, CNT-600, FSJ4, LDF4 series	1316MCLICK, 2-Stack	3 (0.91)	3 (0.91)	3 (0.91)
13mm-16mm	CNT-500, CNT-600, FSJ4, LDF4 series	1316MCLICK, 3-Stack	2 (0.61)	2 (0.61)	2 (0.61)

* These hanger spacings have been specified based on using the Click-On hangers with Andrew specified hardware kits.

Definitions and Assumptions 1. Per EIA-222 Standard: Coefficient of drag for coaxial cable is 1.2 (cylindrical members). Ice forms completely around member (360 degrees). Combined wind and ice loading is reduced by 25% to reflect lower probability of wind and ice occurring simultaneously. 2. Wind speeds are maximum, which includes gust factors and exposure factors.

Notes:

Appendixes

Cable Hanger Spacing

Insulated Hangers – Recommended Maximum Hanger Spacing

Cable Size	Cable Type Number	Hanger Type Number	Recommended Maximum Hanger Spacing, feet (meters)					
			85 mph (137 km/h)			100 mph (160 km/h)		
			Wind Speed: Radial Ice:	No Ice	1/2" (13mm)	1" (25mm)	No Ice	1/2" (13mm)
1/4"	FSJ1-75A	11662-3	3.5 (1.07)	2 (0.61)	1.5 (0.46)	3 (0.91)	1.5 (0.46)	1 (0.30)
1/4"	HST1-50	11662-3	4.5 (1.37)	2.5 (0.76)	2 (0.61)	4 (1.22)	2 (0.61)	1.5 (0.46)
1/4"	LDF1-50	11662-3	4.5 (1.37)	2.5 (0.76)	2 (0.61)	4 (1.22)	2.5 (0.76)	1.5 (0.46)
3/8"	EFX2-50	11662-3	5.5 (1.68)	3.5 (1.07)	2.5 (0.76)	4.5 (1.37)	3 (0.91)	2 (0.61)
3/8"	ETS2-50	11662-3	5.5 (1.68)	3.5 (1.07)	2.5 (0.76)	5 (1.52)	3 (0.91)	2 (0.61)
3/8"	FSJ2-50	11662-3	5.5 (1.68)	3.5 (1.07)	2.5 (0.76)	5 (1.52)	3 (0.91)	2 (0.61)
3/8"	HS2RP-50	11662-3	5.5 (1.68)	3.5 (1.07)	2.5 (0.76)	5 (1.52)	3 (0.91)	2 (0.61)
3/8"	HST2-50	11662-3	5.5 (1.68)	3.5 (1.07)	2.5 (0.76)	5 (1.52)	3 (0.91)	2 (0.61)
3/8"	LDF2-50	11662-3	5 (1.52)	3 (0.91)	2.5 (0.76)	4 (1.22)	2.5 (0.76)	2 (0.61)
1/2"	FSJ4-50B	11662-3	5.5 (1.68)	3.5 (1.07)	3 (0.91)	4.5 (1.37)	3 (0.91)	2.5 (0.76)
1/2"	FSJ4-75A	11662-3	5.5 (1.68)	3.5 (1.07)	3 (0.91)	4.5 (1.37)	3 (0.91)	2.5 (0.76)
1/2"	LDF4-50A	11662-3	6 (1.83)	4 (1.22)	3.5 (1.07)	5 (1.52)	3.5 (1.07)	2.5 (0.76)
1/2"	LDF4-75A	11662-3	6 (1.83)	4 (1.22)	3.5 (1.07)	5 (1.52)	3.5 (1.07)	2.5 (0.76)
1/2"	HL4RP-50	11662-3	6 (1.83)	4 (1.22)	3.5 (1.07)	5 (1.52)	3.5 (1.07)	2.5 (0.76)
1/2"	HLT4-50	11662-3	6 (1.83)	4 (1.22)	3.5 (1.07)	5 (1.52)	3.5 (1.07)	2.5 (0.76)
1/2"	HS4RP-50	11662-3	5.5 (1.68)	3.5 (1.07)	3 (0.91)	4.5 (1.37)	3 (0.91)	2.5 (0.76)
1/2"	HST4-50	11662-3	5.5 (1.68)	3.5 (1.07)	3 (0.91)	4.5 (1.37)	3 (0.91)	2.5 (0.76)
1/2"	HT4-50	11662-3	6 (1.83)	6 (1.83)	5.5 (1.68)	6 (1.83)	6 (1.83)	4.5 (1.37)
1/2"	HJ4-50	11662-3	6 (1.83)	6 (1.83)	5.5 (1.68)	6 (1.83)	6 (1.83)	5 (1.52)
7/8"	LDF5-50A	11662-2	6 (1.83)	6 (1.83)	6 (1.83)	6 (1.83)	6 (1.83)	5.5 (1.68)
7/8"	HJ5-50	11662-2	6 (1.83)	6 (1.83)	6 (1.83)	6 (1.83)	6 (1.83)	6 (1.83)
7/8"	HJ5-75	11662-2	6 (1.83)	6 (1.83)	6 (1.83)	6 (1.83)	6 (1.83)	6 (1.83)
7/8"	HT5-50	11662-2	6 (1.83)	6 (1.83)	6 (1.83)	6 (1.83)	6 (1.83)	6 (1.83)
1-1/4"	LDF6-50	33948-5	6 (1.83)	6 (1.83)	6 (1.83)	6 (1.83)	6 (1.83)	6 (1.83)
1-5/8"	HJ7-50A	33948-3	6 (1.83)	6 (1.83)	6 (1.83)	6 (1.83)	6 (1.83)	6 (1.83)
1-5/8"	LDF7-50A	33948-3	6 (1.83)	6 (1.83)	6 (1.83)	6 (1.83)	6 (1.83)	6 (1.83)
2-1/4"	HJ12-50	33948-6	6 (1.83)	6 (1.83)	6 (1.83)	6 (1.83)	6 (1.83)	6 (1.83)
2-1/4"	LDF12-50	33948-6	6 (1.83)	6 (1.83)	6 (1.83)	6 (1.83)	6 (1.83)	6 (1.83)
3"	HJ8-50B	33948-2	6 (1.83)	6 (1.83)	6 (1.83)	6 (1.83)	6 (1.83)	6 (1.83)
4"	HJ11-50	33948-4	6 (1.83)	6 (1.83)	6 (1.83)	6 (1.83)	6 (1.83)	6 (1.83)
5"	HJ9-50	33948-1	6 (1.83)	6 (1.83)	6 (1.83)	6 (1.83)	6 (1.83)	6 (1.83)
5"	HJ9HP-50	33948-1	6 (1.83)	6 (1.83)	6 (1.83)	6 (1.83)	6 (1.83)	6 (1.83)

Definitions and Assumptions 1. Per EIA-222 Standard: Coefficient of drag for coaxial cable is 1.2 (cylindrical members). Ice forms completely around member (360 degrees). Combined wind and ice loading is reduced by 25% to reflect lower probability of wind and ice occurring simultaneously. 2. Wind speeds are maximum, which includes gust factors and exposure factors.

Notes:

Insulated Hangers – Recommended Maximum Hanger Spacing

Cable Size	Cable Type Number	Hanger Type Number	Recommended Maximum Hanger Spacing, feet (meters)					
			125 mph (200 km/h)			150 mph (240 km/h)		
			Wind Speed: Radial Ice:	No Ice	1/2" (13mm)	1" (25mm)	No Ice	1/2" (13mm)
1/4"	FSJ1-75A	11662-3	2.5 (0.76)	1 (0.30)	1 (0.30)	2 (0.61)	1 (0.30)	0.5 (0.15)
1/4"	HST1-50	11662-3	3 (0.91)	1.5 (0.46)	1 (0.30)	2.5 (0.76)	1.5 (0.46)	1 (0.30)
1/4"	LDF1-50	11662-3	3 (0.91)	2.5 (0.76)	1.5 (0.46)	2.5 (0.76)	1.5 (0.46)	1 (0.30)
3/8"	EFX2-50	11662-3	3.5 (1.07)	2 (0.61)	1.5 (0.46)	3 (0.91)	2 (0.61)	1.5 (0.46)
3/8"	ETS2-50	11662-3	4 (1.22)	2.5 (0.76)	1.5 (0.46)	3 (0.91)	2 (0.61)	1.5 (0.46)
3/8"	FSJ2-50	11662-3	4 (1.22)	2.5 (0.76)	1.5 (0.46)	3 (0.91)	2 (0.61)	1.5 (0.46)
3/8"	HS2RP-50	11662-3	4 (1.22)	2 (0.61)	1.5 (0.46)	3 (0.91)	2 (0.61)	1.5 (0.46)
3/8"	HST2-50	11662-3	4 (1.22)	2 (0.61)	1.5 (0.46)	3 (0.91)	2 (0.61)	1.5 (0.46)
3/8"	LDF2-50	11662-3	3.5 (1.07)	2 (0.61)	1.5 (0.46)	2.5 (0.76)	1.5 (0.46)	1 (0.30)
1/2"	FSJ4-50B	11662-3	3.5 (1.07)	2.5 (0.76)	2 (0.61)	3 (0.91)	2 (0.61)	1.5 (0.46)
1/2"	FSJ4-75A	11662-3	3.5 (1.07)	2.5 (0.76)	2 (0.61)	3 (0.91)	2 (0.61)	1.5 (0.46)
1/2"	LDF4-50A	11662-3	4 (1.22)	3 (0.91)	2 (0.61)	3 (0.91)	2.5 (0.76)	1.5 (0.46)
1/2"	LDF4-75A	11662-3	4 (1.22)	3 (0.91)	2 (0.61)	3 (0.91)	2.5 (0.76)	1.5 (0.46)
1/2"	HL4RP-50	11662-3	4 (1.22)	3 (0.91)	2 (0.61)	3 (0.91)	2.5 (0.76)	1.5 (0.46)
1/2"	HLT4-50	11662-3	4 (1.22)	3 (0.91)	2 (0.61)	3 (0.91)	2.5 (0.76)	1.5 (0.46)
1/2"	HS4RP-50	11662-3	3.5 (1.07)	2.5 (0.76)	2 (0.61)	3 (0.91)	2 (0.61)	1.5 (0.46)
1/2"	HST4-50	11662-3	3.5 (1.07)	2.5 (0.76)	2 (0.61)	3 (0.91)	2 (0.61)	1.5 (0.46)
1/2"	HT4-50	11662-3	6 (1.83)	5 (1.52)	3.5 (1.07)	6 (1.83)	4 (1.22)	3 (0.91)
1/2"	HJ4-50	11662-3	6 (1.83)	6 (1.83)	4 (1.22)	6 (1.83)	6 (1.83)	3 (0.91)
7/8"	LDF5-50A	11662-2	6 (1.83)	5.5 (1.68)	4.5 (1.37)	5 (1.52)	4.5 (1.37)	3.5 (1.07)
7/8"	HJ5-50	11662-2	6 (1.83)	6 (1.83)	6 (1.83)	6 (1.83)	6 (1.83)	5 (1.52)
7/8"	HJ5-75	11662-2	6 (1.83)	6 (1.83)	6 (1.83)	6 (1.83)	6 (1.83)	5 (1.52)
7/8"	HT5-50	11662-2	6 (1.83)	6 (1.83)	6 (1.83)	6 (1.83)	6 (1.83)	5.5 (1.68)
1-1/4"	LDF6-50	33948-5	6 (1.83)	6 (1.83)	6 (1.83)	6 (1.83)	6 (1.83)	6 (1.83)
1-5/8"	HJ7-50A	33948-3	6 (1.83)	6 (1.83)	5.5 (1.68)	6 (1.83)	6 (1.83)	4.5 (1.37)
1-5/8"	LDF7-50A	33948-3	6 (1.83)	6 (1.83)	6 (1.83)	6 (1.83)	6 (1.83)	6 (1.83)
2-1/4"	HJ12-50	33948-6	6 (1.83)	6 (1.83)	6 (1.83)	6 (1.83)	6 (1.83)	6 (1.83)
2-1/4"	LDF12-50	33948-6	6 (1.83)	6 (1.83)	6 (1.83)	6 (1.83)	6 (1.83)	6 (1.83)
3"	HJ8-50B	33948-2	6 (1.83)	6 (1.83)	6 (1.83)	6 (1.83)	6 (1.83)	6 (1.83)
4"	HJ11-50	33948-4	6 (1.83)	6 (1.83)	6 (1.83)	5 (1.52)	5 (1.52)	4.5 (1.52)
5"	HJ9-50	33948-1	4.5 (1.37)	4.5 (1.37)	4.5 (1.37)	3 (0.91)	3 (0.91)	3 (0.91)
5"	HJ9HP-50	33948-1	4.5 (1.37)	4.5 (1.37)	4.5 (1.37)	3 (0.91)	3 (0.91)	3 (0.91)

Definitions and Assumptions 1. Per EIA-222 Standard: Coefficient of drag for coaxial cable is 1.2 (cylindrical members). Ice forms completely around member (360 degrees). Combined wind and ice loading is reduced by 25% to reflect lower probability of wind and ice occurring simultaneously. 2. Wind speeds are maximum, which includes gust factors and exposure factors.

Notes:

Bulletin TP-100433.2-EN (10/08)
Copyright © 2008 by CommScope, Inc.
Hickory, NC 28603 USA

**All designs, specifications, and availabilities of
products and services presented in this
document are subject to change without notice.**



www.commscope.com

Visit our Web site or contact your local Andrew representative for more information.

© 2008 CommScope, Inc. All rights reserved.

Andrew is a trademark of CommScope. All trademarks identified by ® or ™ are registered trademarks or trademarks, respectively, of CommScope.

This document is for planning purposes only and is not intended to modify or supplement any specifications or warranties relating to Andrew products or services.

Printed in USA